



CPQP

TOOLSET
GUIDELINE 3

Design for Manufacture & Assembly Guideline

Version 1.0

August 2022



CONSTRUCTION
INNOVATION HUB



UK Research
and Innovation

Contents

Use of this Guide	5
Introduction	6
Basic Overview	7
Purpose	9
Benefits	10
How does DfMA fit in with Construction Product Quality Planning?	10
Methodology	11
Team Approach	12
Process Overview	13
Functional Analysis	14
Manufacturing Analysis	15
Handling Analysis	15
Assembly Analysis	15
Guideline	16
Functional Analysis	17
Manufacturing Analysis	19
Handling Analysis	28
Assembly Analysis	28
Worked Example: Evaluating and Optimising a Generic Staple Remover	34
Functional Analysis	35
Manufacturing Analysis	38
Handling Analysis	43
Assembly Analysis	45
References and Appendices	52
References	53
Appendix A. DfMA Worksheet	54
Appendix B. List of Abbreviations	54
Appendix C. Glossary of Terms	54
Appendix A. DfMA Analysis Worksheet	55

List of figures

Figure 1. Construction Product Quality Planning's DfMA framework	8
Figure 2. Impact vs. cost across the product development cycle	9
Figure 3. How DfMA fits into the CPQP process	10
Figure 4. DfMA process overview	13
Figure 5. Functional analysis flowchart, adapted from Lucas Engineering & Systems Ltd and University of Hull (1994)	18
Figure 6. Design for Manufacture stages of analysis	19
Figure 7. Applicable process and initial material selection example.	21
Figure 8. Expansion of possible materials example.	22
Figure 9. Human factors, lifting and lowering risk factors, adapted from British Standards Institution (2017)	24
Figure 10. Handling index calculation example	27
Figure 11. Assembly sequence flowchart in process example	28
Figure 12. Assembly analysis example	33
Figure 13. Staple remover, concept iteration 0	35
Figure 14. Functional analysis of staple remover, concept iteration	36
Figure 15. Functional analysis of staple remover, concept iteration	37
Figure 16. Staple Remover, concept iteration 2, exploded view	42
Figure 17. Handling analysis results for the baseline design, concept iteration 0	44
Figure 18. Handling analysis results for concept iteration 1	44
Figure 19. Handling analysis results for concept iteration 2	44
Figure 20. Assembly sequence flowchart for baseline design, concept iteration 0 shown in progress	45
Figure 21. Secondary operation examples	46
Figure 22. Completed assembly sequence flowchart for concept iteration 1	48
Figure 23. Completed assembly sequence flowchart for baseline design, concept iteration 0	49
Figure 24. Completed assembly sequence flowchart for concept iteration 2	51
Figure 25. Completed DfMA Analysis for concept iteration 3	51

List of tables

Table 1. Shape and complexity categories, adapted from Swift & Booker (2003)	20
Table 2. Size and weight (HA) scoring, adapted from Swift & Miles (1985)	25
Table 3. Handling difficulties (HB) scoring, adapted from Swift & Miles (1985)	25
Table 4. End-to-End orientation (HC) scoring, adapted from Swift & Miles (1985)	26
Table 5. Rotational orientation (HD) scoring, adapted from Swift & Miles (1985)	26
Table 6. Work handling operations scoring, adapted from Leaney (1996)	29
Table 7. Secondary operations scoring, adapted from Leaney (1996)	29
Table 8. Fitting score example	30
Table 9. Part placement and fastening fitting score (FA), adapted from Swift & Miles (1985)	30
Table 10. Process direction fitting score (FB), adapted from Swift & Miles (1985)	31
Table 11. Process type fitting score (FC), adapted from Swift & Miles (1985)	31
Table 12. Access fitting score (FD), adapted from Swift & Miles (1985)	31
Table 13. Alignment fitting score (FE), adapted from Swift & Miles (1985)	31
Table 14. Insertion force fitting score (FF), adapted from Swift & Miles (1985)	32
Table 15. Manufacturing analysis steps 1-4 for the baseline design, concept iteration 0	38
Table 16. Manufacturing analysis steps 5-9 for the baseline design, concept iteration 0	41
Table 17. FI calculation for baseline design, concept iteration 0, assembly processes.	48

Use of this Guide

The Design for Manufacture & Assembly (DfMA) guideline is part of the Construction Product Quality Planning (CPQP) process and should be used in conjunction with the CPQP Guide and its toolset, published by the Construction Innovation Hub.

This document is intended to be a guideline in the process of using DfMA by providing the basic principles and a suggested methodology. The templates provided can be changed and modified to suit individual companies.

This guideline is aimed at companies that manufacture offsite construction products and use the CPQP process with their customers and

suppliers. It is intended to provide enough knowledge to enable the CPQP team to complete a DfMA, particularly where this subject is new to them, as well as to provide an ongoing aid. Over time, companies will develop their own expertise, methods and standards through training and practice.

For a list of the acronyms and abbreviations used in this document, refer to Appendix B – List of Abbreviations.

For the various terms used in this document, refer to Appendix C – Glossary of Terms.

For further information about the CPQP Guide and its toolset please contact: cpqp@constructioninnovationhub.org.uk

Introduction

Introduction

The construction industry today is on the verge of transformation, one that will lead to the expanded use of Modern Methods of Construction (MMC) throughout the built environment. The term Design for Manufacture and Assembly (DfMA) is often misused within the industry to describe this paradigm shift. This is understandable as its use often implies a shift from purely traditional methods of construction to the incorporation of offsite pre-manufactured products and components; but DfMA is not limited to the narrow scope implied with this colloquial usage.

'DfMA' is an established methodology that has been used by the wider manufacturing sector for decades. It is a powerful, quantitative tool for the systematic analysis and maturation of design concepts into fully developed designs, that optimise for assembly time and manufacturing cost to ensure a consistent quality.

Basic Overview

DfMA is made up of two separate but interrelated ideologies: Design for Assembly (DfA) and Design for Manufacture (DfM). Prior to DfMA, the prevailing wisdom taught that easy-to-manufacture parts with an emphasis on eliminating unnecessary complexity was the best way forward. This began to change in the late 1970s when it was demonstrated that it can be more cost effective, and deliver a more consistent quality, to focus on product designs that are easier to build in general.

There are many different approaches to DfMA today, often embedded within software solutions.

While the specifics or order of operations may vary, all approaches align in these key principles:

- Optimise overall part count;
- Incorporate self-locating features;
- Use self-fastening features;
- Minimise rotation in assembly;
- Design parts for retrieval, handling and insertion;
- Design for top-down assembly;
- Minimise the use of fasteners;
- Encourage modular design;
- Design the base to locate other parts;
- Design component symmetry for ease of insertion;
- Standardise parts and materials;
- Create modular assemblies;
- Design for efficient joining;
- Simplify and reduce manufacturing steps; and
- Specify surface finishes for functionality.

The quantitative approach detailed in this guideline is based on the process developed in collaboration by Lucas Engineering Systems and the University of Hull (known as the Lucas Hull method) [1]. It has been adapted to support product design within a construction supply chain that is actively engaged with Construction Product Quality Planning (CPQP).

Integral to this method is the focus on simultaneous engineering; developing the design concurrently with the manufacturing and assembly processes.

Design reviews bring together a panel of multi-disciplined decision makers to combine their broader range of viewpoints and skillsets towards the project's ultimate

success. This prevents tunnel vision from driving a project too far in the wrong direction and encourages more innovative solutions.

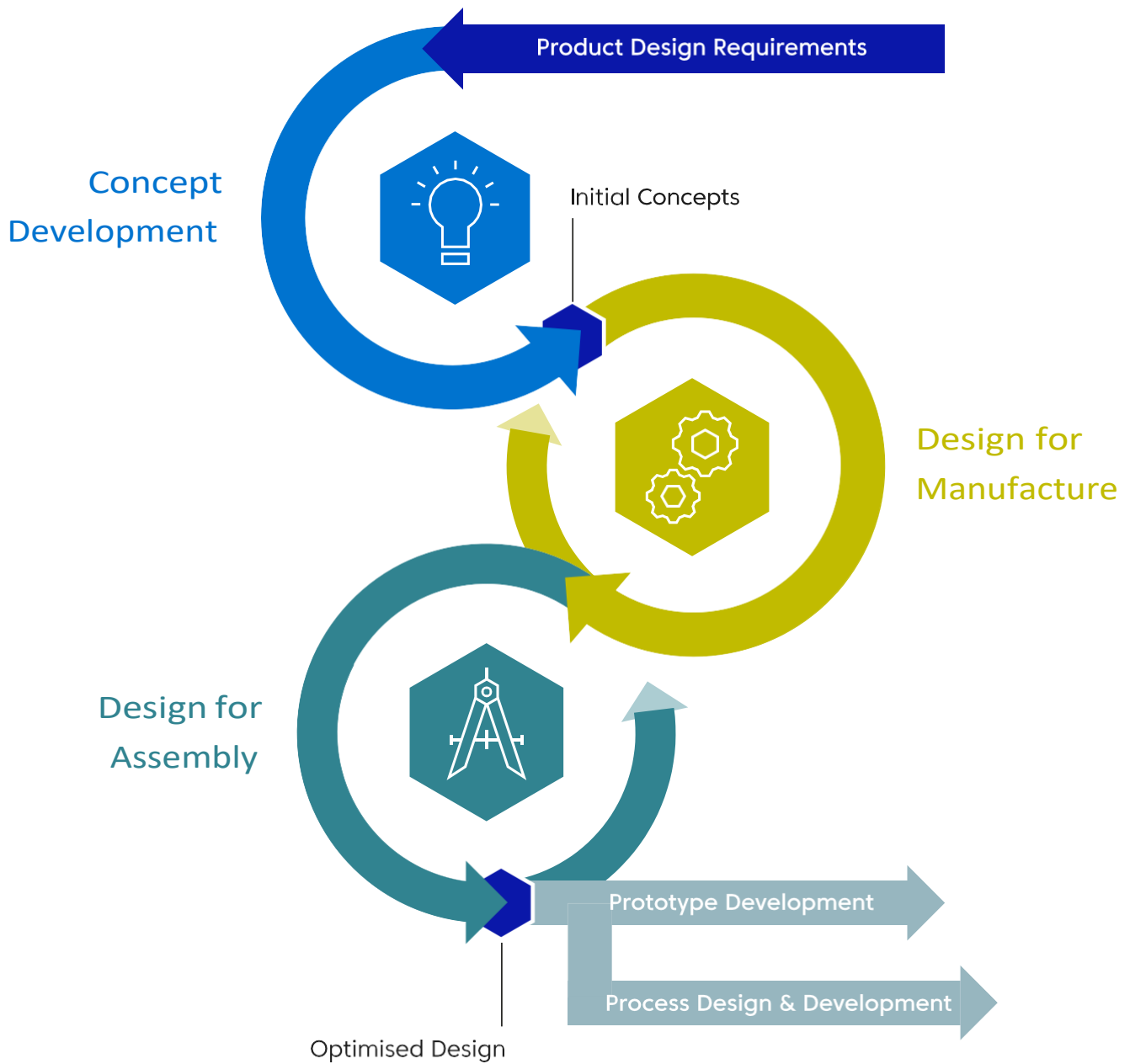

Figure 1. Construction Product Quality Planning's DfMA framework

Purpose

DfMA tools and supporting systems are applied across the manufacturing industry to reduce the time it takes to bring a new product to market. These tools also help to reduce risk. This is accomplished by shifting away from a lone-designer approach, bringing together the various disciplines across a business into a cross-functional development team, and by making product and process design activities more efficient.

These simple changes encourage knowledge sharing throughout the product development cycle and allows for feedback to be received, concerns voiced, and solutions discussed when design modifications are both cheaper and easier to implement (as shown in Figure 2).

Taken together as a complete approach, DfMA is used for two main activities [2]:

- As the basis for concurrent engineering studies, which provide guidance to simplify the product structure, to reduce manufacturing and assembly costs and to quantify those improvements; and
- As a benchmarking tool, to study competitors' products and to quantify manufacturing assembly difficulties.

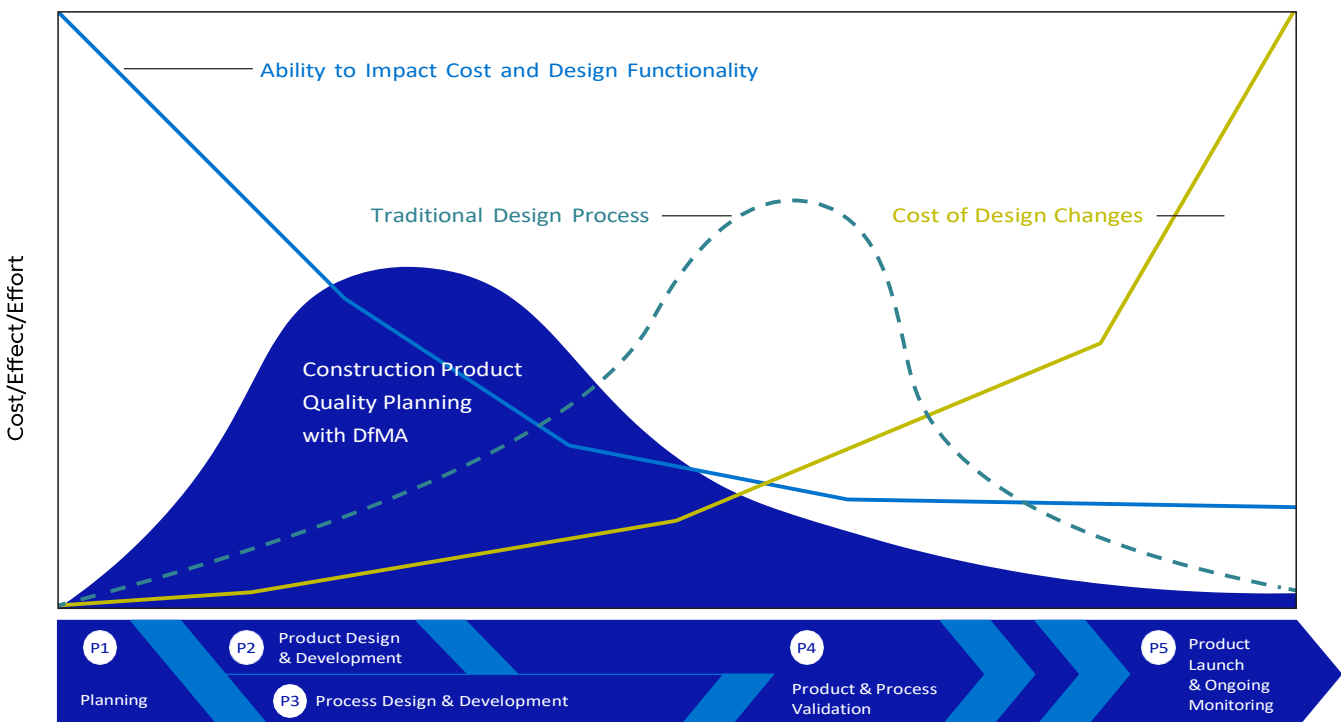

Figure 2. Impact vs. cost across the product development cycle

Benefits

The adoption of DfMA in the manufacturing sector suggests a number of benefits [3], which can be applied to a construction industry that actively engages with CPQP:

- Reduced overall design and manufacturing costs (combined);
- Reduced assembly time and complexity;
- Improved design efficiency and productivity;
- Reduced overhead costs of managing, stocking and dispensing parts to production;
- Shortened assembly lines resulting in a reduction in work in progress and logistics costs; and
- Improved balance of manufacturing investment with long-term assembly costs.

Convincing teams to rely on cost and cycle time estimates for each design choice can be difficult. However, implementing DfMA early in the product development cycle allows concepts to be fully explored and refined when risk and cost is low. This can ultimately lead to a better product, faster, whilst minimising risk.

How does DfMA fit in with Construction Product Quality Planning (CPQP)?

The CPQP process has been broken down into five phases. The second phase is concerned with product design and development. The third phase is process design and development. DfMA is an output of phase two that is delivered to phase three. There is a degree of iteration, however, as solutions are optimised; as shown in Figure 3.



Figure 3. How DfMA fits into the CPQP Process

Methodology

Methodology

DfMA as a methodology was developed by a manufacturing industry that was facing customer demands for higher quality products at lower costs amidst a fiercely competitive market [4]. The race to introduce new and better products, faster, put the entire product development cycle under a microscope.

In traditional product development, the design engineer (or a small team) was solely responsible for ensuring that the product met the customer requirements while meeting the quality standards set by the business. Designers may or may not have had practical experience in a production environment or part manufacturing to aid, their concept development.

Under the time pressure of competition, products could be put to market with excessive numbers of parts and unnecessarily complicated assembly requirements. Avoidable machining and manufacturing requirements were also being "designed in", resulting in as much as 30% of product development effort wasted on part rework [4].

Facing uncontrolled development costs and late changes paired with intimidating quality losses, the industry understood that they needed to include marketing, suppliers and customer representatives in the product development team to better inform the design early on. They needed to involve manufacturing, process, and

others with practical experience to better shape both the concept development and the process design simultaneously. They needed to work as a team. Most importantly, they needed a way to both understand and measure the consequences of design decisions. This was delivered by DfMA.

Team Approach

Construction Product Quality Planning (CPQP) is built upon a team approach. DfMA offers an early need for the formation of this cross-functional project team. Who forms this team will vary by organisation and the needs of the product, but should include members from a variety of disciplines with relevant knowledge and experience, i.e. design engineering, process engineering, manufacturing engineering and quality. It should also include either an external customer representative or an internal party who represents the customer. For larger projects, a supplier representative may be appropriate as well. Finally, the team should include representatives from a non-technical background, such as marketing or sales, to review designs from a different perspective.

This multi-disciplined approach will allow a broader set of views and skills to contribute to the project success. The project team will have better combined knowledge and understanding of the project allowing minor issues to be identified earlier and solutions implemented. This prevents the escalation of larger and potentially catastrophic issues, and should larger issues arise, they are more likely to find the correct solution.

Process Overview

DfMA is a process that subjects design concepts to a series of analyses, each aimed at quantifying and improving a different aspect of the design.

The four key stages, as shown in Figure 4, are:

1. Functional Analysis;
2. Manufacturing Analysis;
3. Handling Analysis; and
4. Assembly Analysis.

The Functional Analysis takes place first, followed directly by the Manufacturing Analysis. These steps can be iterative in nature and early concepts may cycle through this process several times.

The Handling Analysis is then conducted, followed by the Assembly Analysis. As before, there may be design iterations once completed.

Each stage provides a different metric to establish whether the current concept(s), in whole or in part, may be considered 'efficient'. These targets should be viewed as general rules of thumb, designed to encourage discussion and conscious compromises feeding design decisions. As the implementation of the DfMA process matures within an organisation, new internal guidelines based upon past experience may be used in their stead.

In all cases, however, only once the design has been optimised is the time and expense put forward for prototype development.

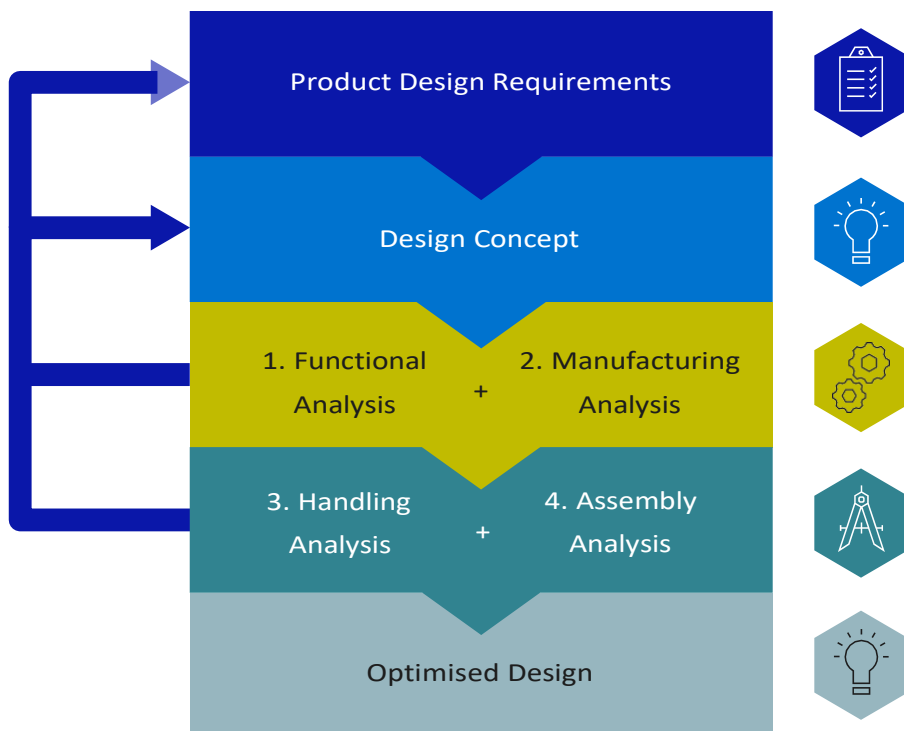

Figure 4. DfMA Process Overview

Functional Analysis

The primary aim of the Functional Analysis is a reduction in the overall part count. The design is evaluated and aspects of it are challenged. Are there unnecessary fasteners being used? Could a different method of securing the componentry be used? Could several parts be merged into one and still provide the same functionality? Has the design been error proofed?

To accomplish this, each part is evaluated with respect to how essential that individual part is to achieving the desired functionality of the final product. We do this by asking three key questions:

- Does the part move?
- Must the part be of a different material or otherwise isolated?
- Will the part need removal or replacement for regular maintenance or service?

Posing these questions in a structured way, we put each part into one of two groups: those that are essential to overall function (or 'A' parts) and those that are non-essential (or 'B' parts).

Once the parts are categorised in this way, the design can be refined to eliminate as many of the non-essential parts as possible. This is typically accomplished by transferring their key design functions into one or more existing essential parts, thus allowing that part to be removed entirely from the assembly.

Manufacturing Analysis

The Manufacturing Analysis then balances the Functional Analysis. It enables the team to measure the effect of any increased part complexity that accompanies the part count reduction by looking at the manufacturability of the individual piece parts deemed 'essential'.

The Manufacturing Analysis considers the materials, manufacturing processes and aspects such as shape complexity, tolerances and quantities, to stimulate ideas for part combination and cost comparisons for alternative manufacturing processes' [4].

The key objectives of the Manufacturing Analysis are to understand:

- The sensitivity of the design to manufacturing variability;
- The ability of the design to use commonly sourced materials and not bespoke sizes or shapes;
- The complexity of manufacturing driven by the part design and the cost impact that has on the overall project;
- The best options for manufacturing processes driven by the design and the demand quantities required; and
- Any tolerance stack-ups that could lead to clash conditions.

Together, the Functional and Manufacturing Analyses fuel a dialogue within the team to ensure that design decisions are taken with intention and with a better understanding of the consequences.

Handling Analysis

The Handling Analysis is an evaluation of the individual piece parts and their ability to be handled and fitted into place manually.

Manual assembly refers primarily to assembly operations being performed by human operators, using their inherent dexterity, skill and judgement [4]. This may require the assistance of a lift, or additional people to safely manipulate heavy, large, or cumbersome items.

The Handling Analysis evaluates each piece part (both essential and non-essential) with respect to their size, weight and any traits that could complicate manual handling (such as fragility or slipperiness). It also reviews their overall symmetry in several directions to highlight the risk of incorrect assembly.

This analysis is completed in a structured way that outputs a handling index for each piece part as well as an overall ratio for the entire assembly. These values provide an easy 'go/no go' gauge with regards to manual handling. They also provide individual scores, immediately highlighting which parts in the assembly may benefit from increased scrutiny.

Assembly Analysis

The Assembly Analysis involves the creation of an assembly sequence flowchart by the cross-functional design team. Each assembly operation within the sequence is identified and scored.

Each individual score provides a measurement for the ease of assembly at the operation level. They can also be used to identify any additional operations that add unnecessary time or cost to the overall assembly of the product.

The scores are then summed into sub-assembly and overall assembly totals which are used to determine the overall assembly ratio. This ratio balances the assembly difficulty with the number of essential parts contained therein to provide a quantitative measurement of the given design's complexity.

Together, the Handling Analysis and Assembly Analysis provide a means of evaluating the impact of the design onto the ability to assemble the final product, both at a piece part and an overall assembly level.

Guideline

Guideline

Functional Analysis

The Functional Analysis takes place early in the product development cycle and is used to evaluate a variety of concepts and iterate on the most promising. This process results in a functional design efficiency being calculated for each concept. This value will indicate whether the concept being evaluated is optimal, or if further simplification of sub-components should be considered to reduce the number of parts and operations. It is also useful in providing an objective comparison of the different concepts being proposed.

Step 0: Select a concept.

Step 1: Select the base part

Select the primary part in the assembly or sub-assembly. This will be considered the 'base part' and is assumed to be essential ('A' part). Enter this part into the attached worksheet.

Step 2: List the parts in order of assembly

List the additional parts in assembly order below the base part on the attached worksheet. Assign a part identifier to each part, assembly or sub-assembly.

As this analysis is conducted early in the design process, the identifier can be theoretical and does not require a formal part number to be issued.

Do not include consumables such as fuel, coolant, sealants, adhesives or lubricants in this list; those will be factored in during the Assembly Analysis.

Step 3: Evaluate each part

Evaluate each part by following the flowchart shown in Figure 5. Use this tool to determine which parts are essential ('A' parts) and which are non-essential ('B' parts), and indicate this on the attached worksheet. If in doubt, state 'No'.

Step 4: Calculate the Functional Design Efficiency

Using Equation (1) calculate the functional design efficiency (FE) for the concept being considered.

$$FE = \left[\frac{N_A}{N_A + N_B} \right] \times 100 \quad (1)$$

where:

FE = Functional Design Efficiency

N_A = Total number of essential ('A') parts

N_B = Total number of non-essential ('B') parts

As a general rule of thumb, a Functional Design Efficiency of 60% or higher is considered good

Step 5: Redesign

A Functional Design Efficiency below 60% indicates a design concept that could benefit from re-evaluation by the team.

Could any of the fasteners be made redundant?
Can serviceability be achieved with the use of only one or two fasteners? Could any of the parts be combined into one and still provide the same functionality? See the worked example section for a guide on how this can look in practice.

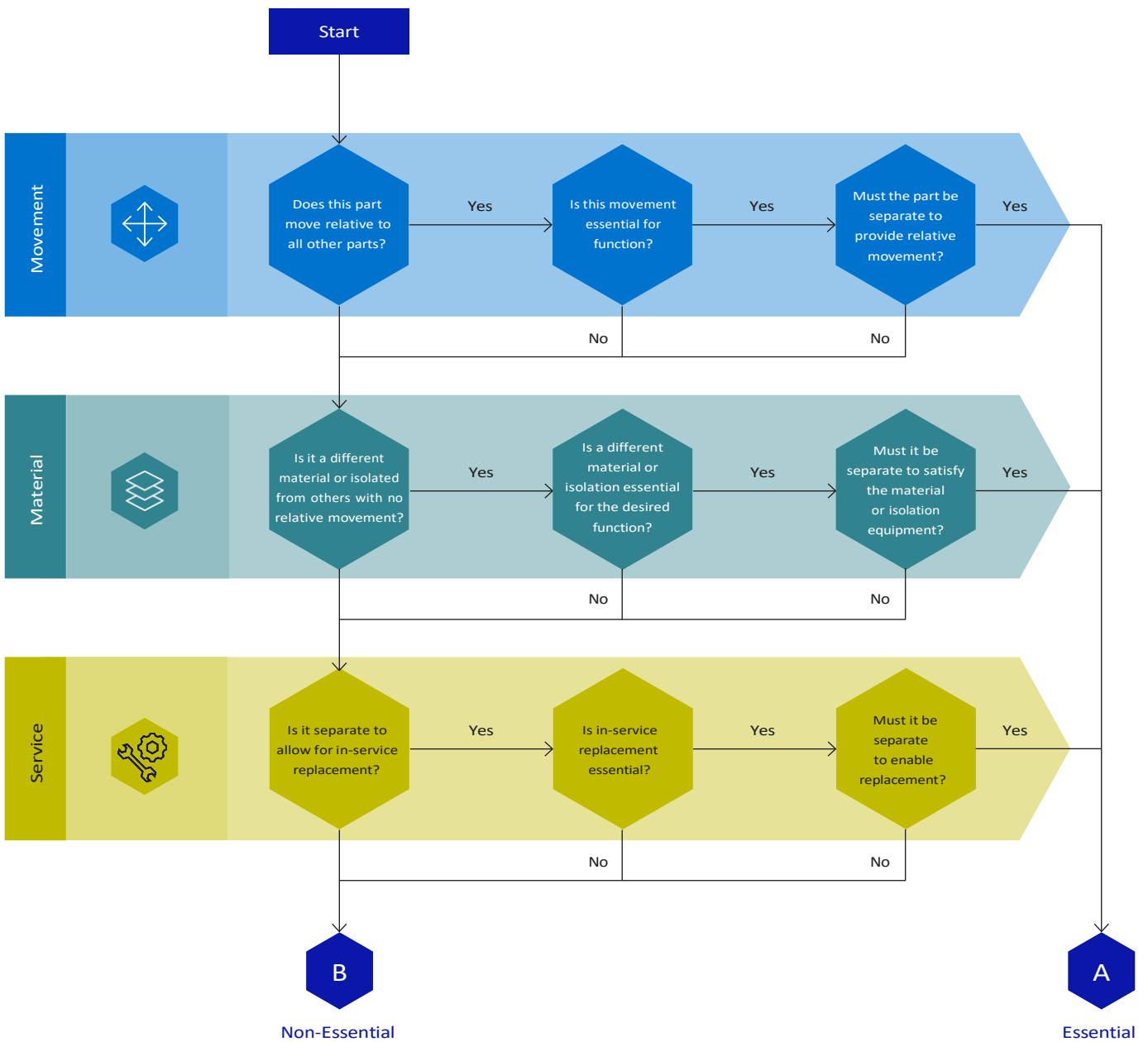

Figure 5. Functional analysis flowchart, adapted from Lucas Engineering & Systems Ltd and University of Hull (1994)

Manufacturing Analysis

The Functional Analysis will provide you with a series of concept iterations that have been simplified to varying degrees but still meet the functional requirements of the product. The next step is to evaluate the essential ('A') parts for their manufacturability in order to simplify and reduce the number of manufacturing operations.

This should be done with the original concept as well as at least one of the concept iterations generated in the Functional Analysis. A comparison of the two will provide a measurement for the effect of any increased part complexity that accompanied the part count reduction. This will form the foundation of informed discussion within the team on which concept(s) to take forward in the process.

For each essential ('A') part, the most appropriate material(s) and manufacturing route(s) should be

identified. This involves a systematic down-selection of processes, against a defined set of criteria, progressively zooming in to identify the most appropriate material(s) and process(es) for the job.

While the sequence of the Manufacturing Analysis as shown in Figure 6 is important, an iterative approach is required. It will be necessary to revisit preceding sections to ensure they are still valid, based on the outcome of subsequent decisions.

The advantage of this systematic approach is that it helps to avoid the status quo attitude, encouraging the question: Could this part be made using this method? It also ensures that there aren't any unconsciously designed-in limitations that constrain the part to a specific material or manufacturing process, that may not be justified by the volumes of product to be delivered.



Figure 6. Design for Manufacture stages of analysis



Shape		Complexity		Details
 Cylindrical Part Envelope (Solid of Revolution)	Single Axis	A1	Basic rotational features only	Rotational symmetry, grooves, undercuts, steps, chamfers, tapers and holes along the primary axis or centre lines
		A2	Regular secondary/repetitive features	Internal/external threads, knurling and simple contours through flats, splines, keyways on or around the primary axis or centre line
	Secondary Axis	A3	Internal	Holes, threads, counter-bores and other internal features not on the primary axis
		A4	Internal or external features	Projections, complex features, blind flats, splines, keyways on secondary axes
	Complex	A5	Irregular or complex forms	Complex contoured surfaces and/or series of features that are not represented in previous categories
 Rectangular/Cubic Prism Part Envelope	Single Axis or Plane	B1	Basic features only	Through steps, chamfers and grooves, channels, slots and holes, threads on a single axis
		B2	Regular secondary/repetitive features	Regular through features, T-slots and racks, plain gear sections, etc., repetitive holes, threads, counter-bores on a single plane
	Multiple Axis	B3	Orthogonal/straight line based features	Regular orthogonal or straight straight line based pockets, projections on one or more axis, angled holes, threads, and counter-bores
		B4	Simple curved features on a single plane	Curves in internal or external surfaces
	Complex	B5	Irregular and/or contoured forms	Complex three-dimensional (3D) contoured surfaces, geometries that cannot be assigned to previous categories
 Flat or Thin-walled Section Components	Single Axis	C1	Basic features only	Blanks, washers, simple bends, forms and through features on or parallel to primary axis
	Secondary or Repetitive Regular Features	C2	Uniform section or wall thickness	Plain cogs and gears, multiple or continuous bends and forms
		C3	Non-uniform section or wall thickness	Section changes not made up of multiple bends or forms, steps, tapers, and blind features
	Regular Forms	C4	Cup, cone, and box-type parts	Components may involve changes in section thickness
	Complex	C5	Non-uniform and/or contoured parts	Complex or irregular features or series of features which are not represented in previous categories

Table 1. Shape and complexity categories, adapted from [4]

Step 1: Shape analysis

The first step is to classify each essential ‘A’ part within a series of basic shapes, as detailed in the first column of Table 1. Is the part envelope broadly cylindrical, rectangular (or cubic), or composed of flat or thin-walled sections? This initial analysis will rule in/out certain processes, based on their ability to produce the shapes required.

For instance, cylindrical objects, either the finished part or the tooling required to make that part can be created by rotating the part relative to a tool; an example is lathe turning. By contrast, planar surfaces can be achieved by rotating a tool and moving it linearly in relation to the part; milling is an example of this. Similarly, processes such as extrusion exhibit linear directionality.

Step 2: Complexity analysis

The next step is to classify the complexity of the shape (see the second column of Table 1). Complexity considers the number, profile and relative orientation of different features. The greater the complexity, the harder it will

be to make. Greater complexity may also filter out certain processes, which are incompatible with complex features.

For instance, an extrusion is an inherently two-dimensional (2D) process and unlikely to be capable of delivering a complex three-dimensional form.

Step 3: Applicable process selection

Appropriate processes are then identified, which are capable of achieving the basic shape envelopes necessary to meet the part functionality. Do not worry at this stage which is most suitable, that will come later. Instead focus on what could be. At the same time, this will rule out those processes which are inherently unsuitable.

Figure 7 shows an example of this process brainstorming exercise using a generic sub-assembly from the worked example. See the worked example section for further details.

Part No.	Part Description	FA	Shape	Manufacturing Processes											Material			
				Die Casting	Sand (Investment) Casting	Extrude/Machine & Pierce	Stamping/Press Brake	Laser Cut/Press Brake	Roll Forming/Pierce	CNC Punch & Form	Metal Injection Moulding	3D Printing	Cold Forming	Hot Forming	Plastic Moulding	Vacuum Forming	Metal	Plastic
A	Jaw	A	C2	X	X	X	X	X	X	X	X	X	X	X	X	X	X	X
B	Grip	A	B5	X	X	X						X	X			X	X	X

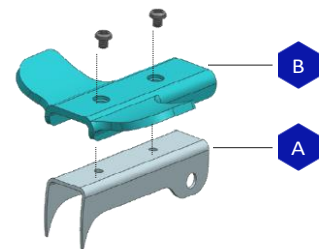

Figure 7. Applicable process and initial material selection example.

Step 7: Quantity analysis

Review the quantities that will be needed in production and factor that information into the process selection.

Quantity Analysis considers the ability to scale production of different processes to meet the demand for the part. For instance, a sand (or investment) casting process may meet all of the functional requirements, but may be incapable of economically scaling up production to support the demand envisaged.

Step 8: Environmental analysis

Each part will carry an environmental impact, regardless of the make vs. buy decision. This will include the carbon footprint associated with the material(s) selected and where these materials are sourced. It will also include any carbon impact inherent to the specific manufacturing process(es). Taking these concerns into account will consider the sustainability and end of life (disposal, re-use, upcycle or recycle) for the part in question.

The carbon footprint of a material or process is typically calculated in grams of fossil based CO₂, CH₄ or N₂O per kg of product. Tables providing appropriate values associated with a given material/process, as well as its transport to the UK (for example, fresh timber from Finland that is processed locally vs. cross-laminated timber imported from Sweden), are commercially available from a variety of sources. This information is also often available through local suppliers upon request.

To avoid becoming bogged down in detailed calculations at this early stage, however, it is recommended that some general research being conducted and each material/process being evaluated is given a carbon footprint score of: Very High, High, Medium, Low and Very Low. This will inform material and process selection

to enable conscious choices in alignment with the UK Government's long-term strategic objectives for greenhouse gas emissions.

Step 9: Cost analysis

The purpose of Cost Analysis is to filter in/out the most economical processes that meet the functional requirements. It considers the relative cost of different manufacturing and assembly processes, taking into account how cost per unit varies by production volume.

Inherent to this step is the make vs. buy decision. Do the volumes needed support the manufacture of a bespoke component or can an off-the-shelf part be purchased for less money and without the capital investment in tooling? Is this factored into the current design? Could a minor modification of the design concept enable this? It is also important to determine the implications of these choices, made at the individual piece part level, upon the overall assembly cost.

Step 10: Redesign and iterate

When the Manufacturing Analysis is complete, it is important for the team to re-evaluate any new design directions taken as a result of the Functional Analysis alone and to select an optimal concept to move forward with. This may require a measure of iteration and re-design until a consensus can be reached.

The value in the paired Functional and Manufacturing Analyses is evident as each part eliminated represents a part that does not need to be installed, maintained, or removed for service. Each manufacturing process eliminated may not impact the carbon footprint or generate waste. Each unnecessary bespoke material, product or process eliminated widens the available supply chain and the options contained within.

Handling Analysis

Once the design has been refined, error-proofed and simplified, the individual components within the optimised design concept(s) should then be evaluated with respect to manual handling. This is inclusive of both essential ('A') and non-essential ('B') parts. This analysis is used to identify any potential problems with the handling of individual elements/operations on the production line that could complicate the assembly sequence and increase costs. This does not cover handling/transportation of products to the assembly line.

Step 1: Size and weight (HA) scoring

Categorise each part by its size and weight by selecting the most appropriate from Table 2. When choosing between large/very large, see Figure 9 for human factors. Choose only one score for each part and enter this value into the attached DfMA Analysis Worksheet.

Step 2. Handling difficulties (HB) scoring

Categorise each part with regards to any manual handling difficulties that could impact assembly cost or cycle time.

If the part is dispensed in some way to the installer (e.g. supplied as standard on a coil, strip, or pallet), the handling difficulty score is zero, regardless of part complexity.

Otherwise, score the part by selecting any appropriate handling difficulties from Table 3 and summing those scores to provide a total for each part. Enter this value into the attached worksheet.

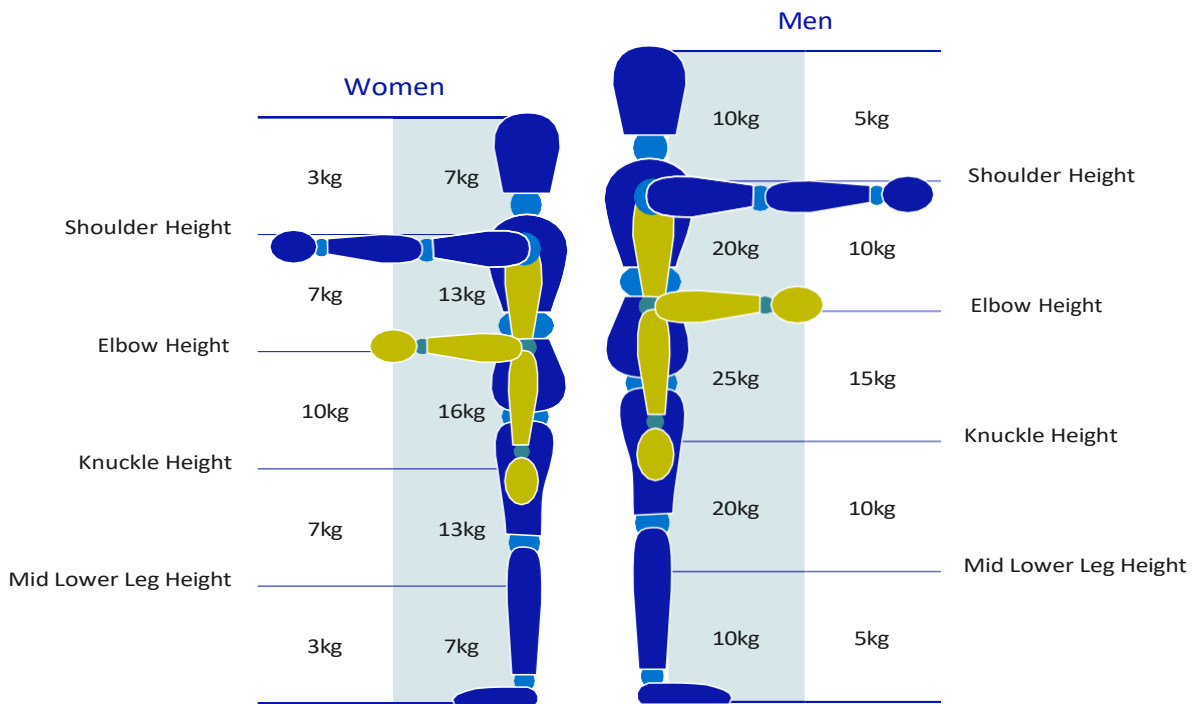

Figure 9. Human factors, lifting and lowering risk factors, adapted from [5]





(H _A) Size & Weight Category		Description	Score
	Very small	Requires vision or handling aids	1.5
	Convenient	Requires one hand only	1
	Large and/or heavy	Requires more than one hand or a grasping aid	1.5
	Very large and/or very heavy	Requires a forklift, hoist mechanism or 2 people	3
Choose one score for each part			

Table 2. Size and weight (H_A) scoring, adapted from [6]

(H _B) Size & Weight Category		Score	(H _B) Handling Difficulties		Score
	No Handling Difficulties	0		Dispensed Part (e.g., supplied on a coil, strip or pallet)	0
If either of the above, stop here					
	Fragile/Delicate	0.4		Severely Nest	0.7
	Flexible	0.6		Sharp/Abrasive	0.3
	Sticky/Adherent	0.5		Untouchable	0.5
	Tangle	0.8		Slippery/Difficult to Grip	0.2
Choose any applicable and add together					

Table 3. Handling difficulties (H_B) scoring, adapted from [6]

Step 3. End-to-end orientation (H_c) scoring

Evaluate the assembly operations associated with each component and score each part on how the design facilitates that assembly. Does the part need to be assembled with a specific end-to-end orientation? If it does, is the orientation easy to identify (and therefore less likely to result in an error) or is it more difficult to identify? Choose one score for each part and its assembly operation from Table 4 and enter it into the worksheet.



(H_c) End-to-End Orientation		Score
	Symmetrical/None Required	0
	Easy to See	0.1
	Not Easy to See	0.5
Choose one score for each part		

Table 4. End-to-End Orientation (H_c) scoring, adapted from [6]

Step 4. Rotational orientation (H_o) scoring

Now evaluate the assembly operations associated with each component in regard to any rotation required to assemble or orient it properly. Is the part rotationally symmetrical? Is it obvious or intuitive (and therefore less likely to result in an error)? Or might it require training or experience to install correctly else additional time to get it right? Choose one score for each part and its assembly operation from Table 5 and enter it into the worksheet.



(H_o) Rotational Orientation		Score
	Symmetrical/None Required	0
	Easy to See	0.2
	Not Easy to See	0.4
Choose one score for each part		

Table 5. Rotational Orientation (H_o) scoring, adapted from [6]

Step 5. Calculate the Handling Index (HI) for each part

Each component will have an HI calculated using Equation (2) by adding their individual handling scores together. This can be accomplished by summing their associated columns from the worksheet as shown in Figure 10.

$$HI = H_A + H_B + H_C + H_D \quad (2)$$

An HI for any individual part that is less than 1.5 is considered efficient. Note any components whose HI exceeds this target for possible attention later.

Step 6. Calculate the overall Handling Ratio (HR) of the assembly

Using Equation (3) calculate the HR for the concept being considered.

$$HR = \frac{\sum HI}{N_A} \quad (3)$$

where:

HR = Handling Ratio

$\sum HI$ = Sum of the individual HI values for the entire assembly

N_A = Total number of essential ('A') parts

An example of this, based upon a generic sub-assembly from the worked example is shown in Figure 10. See the worked example section for further details.

As a rule of thumb, a HR of less than 2.5 can be considered efficient.

Step 7: Redesign

An HR of over 2.5 should prompt a design review with the team. Investigate any individual components with an HI above 1.5 to determine if the issues raised could be addressed with design modifications.

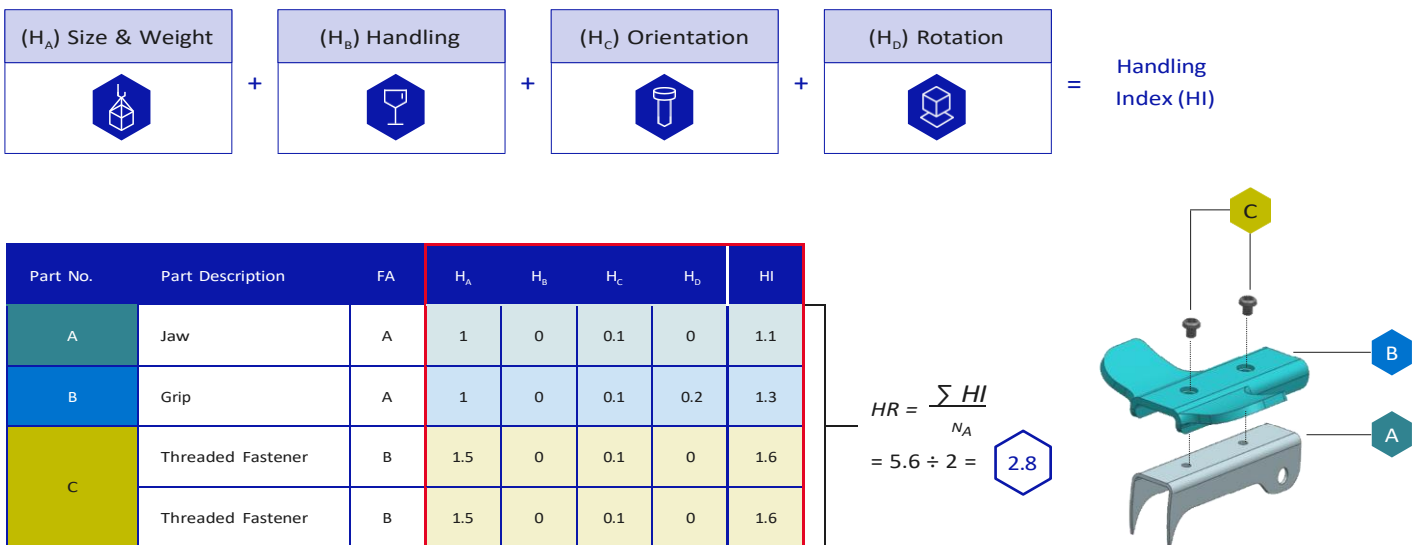

Figure 10. Handling index calculation example

Assembly Analysis









Next, it is time to evaluate the assembly process that has been driven by the design. This analysis reviews any insertion, fixing or part handling processes within the assembly sequence and is used to identify any operations that add unnecessary time or complexity to the overall product assembly.

Step 1. Create an assembly sequence flowchart

The first step is to develop an Assembly Sequence Flowchart for the assembly of the concept design(s) under evaluation. This will eventually feed into a Manufacturing Process Flowchart (see the Manufacturing Process Flow CPQP Toolset Guide) once the product development cycle is more mature and a final concept has been selected. In comparison, the Assembly Sequence Flowchart sets out the assembly operations needed to assemble the product. This can be used to quantify the impact on the assembly process as driven by different design decisions.

The previous analyses have established a list of components in order of assembly. The Assembly Sequence Flowchart builds off of this to designate the assembly operations associated with each component (or sub-assembly).

Assembly operations are defined as:

-  Work (manual) Handling
-  Assembly Process (insertion, fitting, or fixing operations)
-  (Mechanical) gripping (in automated or tool-assisted assembly)
-  Disassembly (or tool insertion)
-  Reassembly (or tool removal)
-  Secondary operations
-  Sub-Assembly Total
-  Assembly Total

These symbols are used to create a graphical representation of the assembly sequence. Figure 11 shows an example of this based upon a generic sub-assembly (see the worked example section for further details).

These symbols will be filled with values in later steps to quantify the impact of each operation.

Part No.	Part Description	FA	HI
A	Jaw	A	1.1
B	Grip	A	1.3
C	Threaded Fastener	B	1.6
	Threaded Fastener	B	1.6

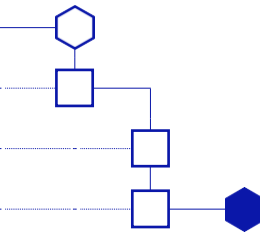
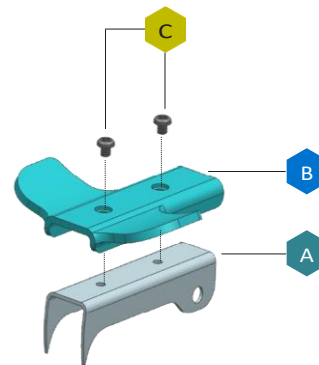



Figure 11. Assembly sequence flowchart in process example

Step 2. Work handling scoring

Each manual handling, disassembly or reassembly, tool insertion or removal, or mechanical gripping process will also have a score. The most common of these is the initial selection of the base part, which receives a score of 0. If there are others, select the appropriate value to use from Table 6.

Step 3. Secondary operations scoring

The score for each secondary operation (as indicated by a triangle) is then added to the Assembly Sequence Flowchart, its value taken from Table 7. Often, new secondary operations are discovered during later steps and the flowchart is updated accordingly.









Work Handling Operations		Score	Work Handling Operations		Score
	Manual Handling (Initial—Base Part)	0		Reassembly/Tool Removal (Easy)	1.5
	Manual Handling (Other)	1.5		Reassembly/Tool Removal (Difficult)	4
	Disassembly/Tool Insertion (Easy)	1.5		Mechanical Gripping (Single)	1
	Disassembly/Tool Insertion (Difficult)	4		Mechanical Gripping (Multiple)	4
Choose one score for each operation					

Table 6. Work handling operations scoring, adapted from [5]











	Secondary Operation	Score		Secondary Operation	Score
	Additional Screwing	4.0		Re-orientation	1.5
	Laser / Mechanical Deformation	4.0		Fill/Empty Fluids (or Fuel)	5.0
	Soldering/Welding	6.0		Take Measurement (Easy)	1.5
	Adhesive/Electrical	5.0		Take Measurement (Difficult)	7.5
Select any/all that apply					

Table 7. Secondary operations scoring, adapted from [5]

Step 4. Calculate the Fitting Index (FI) for each assembly process

For each assembly process, identified by a square on the Assembly Sequence Flowchart, calculate the appropriate FI for that operation. This is a composite of the individual scores, F_A through F_F , added together (see steps 4A through 4G for details). This can be done either manually or using a spreadsheet (as shown in Table 8). This output is then noted inside its associated square on the Assembly Sequence Flowchart.

Step 4A. Part Placement and Fastening fitting score (F_A)

Each operation is assigned one score for part placement and, if the item is secured in place, a second score for fastening. See Table 9 for applicable scores. Sum the two values (part placement plus part fastening) for the operation's F_A score.

Part No.	Part Description	Assembly Operation	Placement	F_{A1}	Fastening	F_{A2}	Process Direction	F_B	Process Type	F_C	Access	F_D	Alignment	F_E	Force	F_F	FI
A	Jaw																
B	Grip		Requires holding	2	-	0	Straight line from above	0	-	0	Direct access	0	Difficult to align	0.7	No resistance	0	
C	Threaded Fastener		Requires holding	2	Screwing	4	Straight line from above	0	Single insertion	0	Direct access	0	Easy to align	0	No resistance	0	
C	Threaded Fastener		Requires holding	2	Screwing	4	Straight line from above	0	Single insertion	0	Direct access	0	Easy to align	0	No resistance	0	

Table 8. Fitting score example

(F_A) Part Placement / Fastening			Score
Part Placing Processes		Self-locating	1
		Requires holding	2
Part Fastening Processes		Self-securing/Snap fit	1.3
		Screwing	4
		Riveting	4
		Bending/Clip or Clamp fastener	4
Choose one placement and one fastening score for each operation			

Table 9. Part placement and fastening fitting score (F_A), adapted from [6]

Step 4B. Process Direction fitting score (F_b)

Ideally, the design will be optimised for a top-down assembly sequence and all insertions will take place vertically down, in order to be assisted by gravity. Identify the direction that each insertion will take and add the appropriate modifier to its F_b score from Table 10.



(F_b) Process Direction		Score
	Straight line from above	0
	Straight line from another direction	0.1
	Not in a straight line (multi-directional motion(s) required)	1.6
Choose one score for each operation.		

Table 10. Process direction fitting score (F_b), adapted from [6]

Step 4D. Access fitting score (F_d)

Evaluate whether or not access or visibility will be restricted during the operation and, if so, include the applicable score taken from Table 12.



(F_d) Access		Score
	Direct access, no visibility restrictions	0
	Restricted access and/or visibility	1.5
Choose one score for each operation.		

Table 12. Access fitting score (F_d), adapted from [6]

Step 4C. Process Type fitting score (F_c)

Evaluate the insertions and identify if those operations will be single or multiple, and if multiple if they will be made in series or simultaneously. Assign the appropriate score from Table 11 to that operation, as required.



(F_c) Process Type		Score
	Single Insertion	0
	Serial multiple insertions	0.7
	Multiple simultaneous insertions	1.2
Choose one score for each operation.		

Table 11. Process type fitting score (F_c), adapted from [6]

Step 4E. Alignment fitting score (F_e)

Evaluate the ease of alignment for the insertion operation and assign the appropriate score from Table 13.



(F_e) Alignment		Score
	Easy to align	0
	Difficult to align	0.7
Choose one score for each operation.		

Table 13. Alignment fitting score (F_e), adapted from [6]

Step 4F. Insertion Force fitting score (F_f)

Evaluate whether or not force should be factored into the insertion operation and, if so, assign the appropriate score from Table 14. Common examples of a resistance to insertion are self-tapping screws or press-fit (interference fit) components.



(F_f) Insertion Force		Score
	No resistance to insertion	0
	Resistant to insertion	0.6
Choose one score for each operation.		

Table 14. Insertion force fitting score (F_f), adapted from [6]

Step 4G. Fitting Index (F_i) calculation

Add together the individual fitting scores, as shown in Equation (4), to calculate the FI. This value is then noted inside its square on the Assembly Sequence Flowchart.

$$FI = F_A + F_B + F_C + F_D + F_E + F_F \quad (4)$$

A Fitting Index (FI) of less than 2.5 is considered efficient. Any assembly processes with a FI that exceeds this value should be investigated in Step 7.

Step 5. Calculate the Assembly Total (AT)

Sum the scores for the complete assembly using Equation (5) and indicate that value on the Assembly Sequence Flowchart with a double walled boxed.

$$AT = \sum FI + \sum WH + \sum SO \quad (5)$$

where:

AT = Assembly Total

$\sum FI$ = Sum of the FI scores

$\sum WH$ = Sum of the Work Handling operation scores

$\sum SO$ = Sum of the Secondary Operations

Step 6. Calculate the overall Assembly Ratio (AR)

Using Equation (6) calculate the overall Assembly Ratio (AR) for the design.

$$AR = \quad (6)$$

where: $\frac{AT}{N_A}$

AR = Assembly Ratio

AT = Assembly Total

N_A = Total number of essential ('A') parts

An example of this, based upon a generic sub-assembly from the worked example, is shown in Figure 12. An assembly with an overall fitting ratio of less than 2.5 is considered efficient.

Step 7. Redesign

A FR of over 2.5 should prompt a design review with the team to see if any operations can be eliminated or made more efficient to improve the ease of assembly.

Step 8. Iterate

Repeat the process for any subsequent iterations on this concept, or for other concepts being evaluated for comparison.

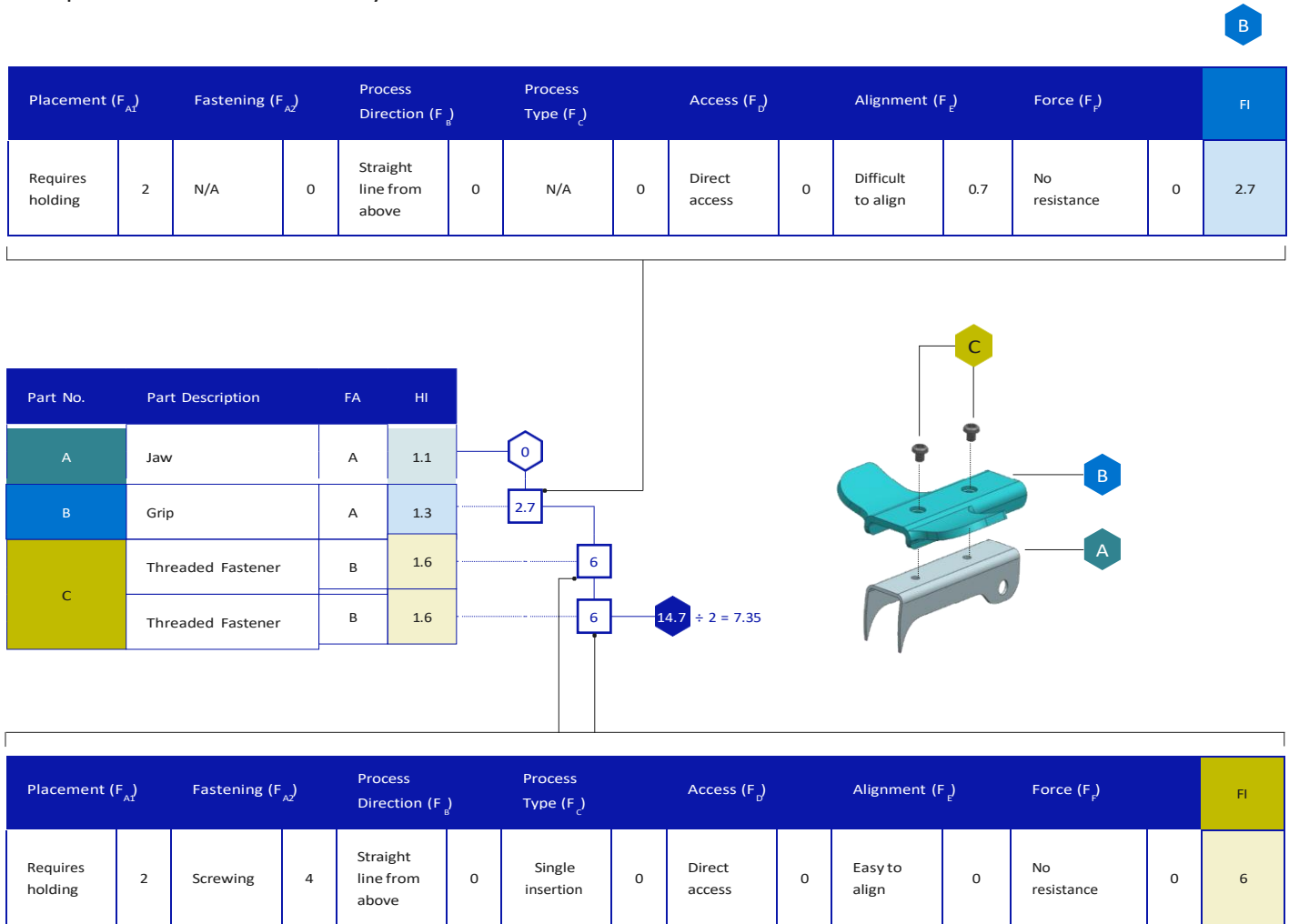

Figure 12: Assembly analysis example



Worked Example: Evaluating and Optimising a Generic Staple Remover

Worked example

The focus of this worked example is the evaluation and optimisation of the generic staple remover shown in Figure 13.

The product design requirements are:

- To remove standard size office staples;
- To avoid damaging paper during use;
- To feature an easy grip handle; and
- To be able to recycle $\geq 80\%$ of components at end of life.

Functional Analysis

Step 0. Select a concept

The initial concept selected is the initial staple remover concept depicted in Figure 13.

Step 1. Select a base part

Looking at the exploded part diagram (see Figure 15), the most appropriate base part is either Jaw-Wide or Jaw-Narrow. It is a somewhat

arbitrary decision, but for this example, we have selected Jaw-Narrow as the base part.

Step 2. List the parts in order of assembly

This assembly is broken down into two separate sub-assemblies that are joined using the spring and pivot components. The parts are grouped accordingly and listed in assembly order on the worksheet.

Step 3. Evaluate each part

Each item is identified as either 'A' (essential) or 'B' (non-essential) per the flowchart from Figure 5 and the worksheet is updated accordingly.

Step 4. Calculate the functional design efficiency

Using Equation (1) the FE of the design is calculated as follows:

$$N_A = 6$$

$$N_B = 5$$

$$FE = \left[\frac{6}{11} \right] \times 100 = 54.5\%$$

This is indicated on the worksheet. See Figure 14 for a worked example of the v1 design concept.



Figure 13: Staple remover, concept iteration 0

Step 5: Redesign

Because the FE is below 60 per cent, we have re-evaluated the design and made the following improvements in iteration 1:

- The pivot bolt and nut (items 7 and 8) have been replaced with a rivet (7.1); and
- The threaded fasteners (5) were reduced in quantity from two to one with the

addition of locating indentations on the underside of the grips (2.1 and 4.1). They have also been replaced with rivets (5.1).

These changes bring the FE of concept iteration 1 to 75 per cent, a more optimised design, depicted in Figure 15.

Part No.	Part Description	FA
1	Jaw-Narrow	A
2	Grip-Narrow	A
5	Threaded Fastener	B
5	Threaded Fastener	B
3	Jaw-Wide	A
4	Grip-Wide	A
5	Threaded Fastener	B
5	Threaded Fastener	B
6	Spring	A
7	Pivot-Barrel Nut	A
8	Pivot-Threaded	B

$N_A = 6$
 $N_B = 5$

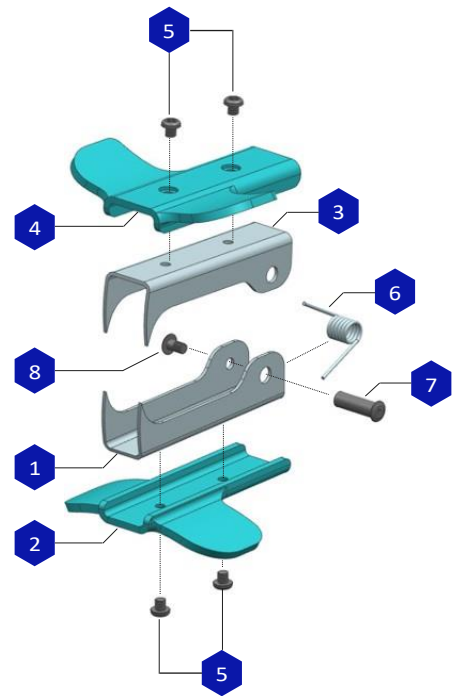

$$FE = \left[\frac{N_A}{N_A + N_B} \right] \times 100 = 54.5\%$$

Figure 14. Functional analysis of staple remover, concept iteration 0

Part No.	Part Description	FA
1.1	Jaw-Narrow	A
2.1	Grip-Narrow	A
5.1	Rivet	B
3.1	Jaw-Wide	A
4.1	Grip-Wide	A
5.1	Rivet	B
6	Spring	A
7.1	Rivet	A

$NA = 6$
 $NB = 2$

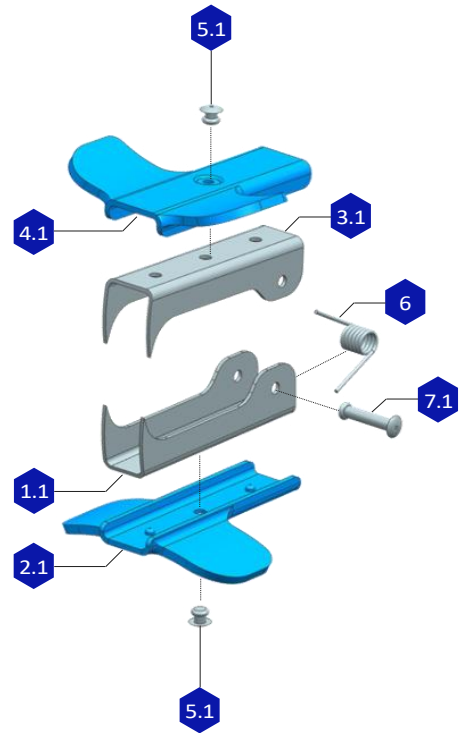

$$FE = \left[\frac{NA}{NA + NB} \right] \times 100 = 75\%$$

Figure 15. Functional analysis of staple remover, concept iteration 1

Manufacturing Analysis

Steps 1 and 2. Shape and complexity analysis

Beginning with the baseline concept iteration 0, assign a shape and complexity classification to each of the essential ('A') parts and update the worksheet accordingly. In this example, the jaws (both narrow and wide) fall under the 'category C2', the grips are B5, while the primary pivot fastener and spring are A2.

Step 3: Applicable process generation

Generate a list of possible manufacturing processes, as generated by the shape and complexity classifications, as shown in Table 15.

Step 4. Material Analysis

Generate a list of potential materials implicit to each part design and collection of manufacturing processes. As shown in Table 15, those parts most likely to be metal had the potential material list refined to consider aluminium, steel, cobalt, and tungsten as appropriate. Likewise, those parts most likely to be plastic were refined to consider high-performance plastics, thermoplastics or ABS, PVA/PVB, high-density polyethylene, and bioplastics.

Part No.	Part Description	FA	Shape	Manufacturing Processes													Material										
				Die Casting	Sand (Investment) Casting	Extrude/Machine & Pierce	Stamping/Press Brake	Laser Cut/Press Brake	Roll Forming/Pierce	CNC Punch & Form	Metal Injection Moulding	3D Printing	Cold Forming	Hot Forming	Machining	Colling	Plastic Moulding	Vacuum Forming	Aluminium	Steel	Cobalt	Tungsten	High Performance Plastic	Thermoplastic/ABS	PVA/PVB	High density Polyethylene	Bioplastic
1	Jaw-Narrow	A	C2	X	X	X	X	X	X	X	X	X	X	X			X		X	X	X	X					
2	Grip-Narrow	A	B5	X	X	X					X	X					X	X		X	X		X	X	X	X	X
3	Jaw-Wide	A	C2	X	X	X	X	X	X	X	X	X					X		X	X	X	X					
4	Grip-Wide	A	B5	X	X	X					X	X					X	X					X	X	X	X	X
6	Spring	A	A2													X	X			X							
7	Pivot-Barrel Nut	A	A2			X										X	X	X	X								

Table 15. Manufacturing analysis steps 1-4 for the baseline design, concept iteration 0

Step 5. Tolerance analysis

Evaluate each essential ('A') part to identify which dimensions need to be held to what level of precision to ensure final functionality. The results of this analysis for the baseline design, concept iteration 0, are as follows:

Jaw-Narrow:

- The axial line for the pivot hole must be held to allow the insertion of the pivot;
- The width of the jaw and the angle of the bends must be such that it will properly nest inside Jaw-Wide; and
- The height of the pivot hole must be held such that the spring will have mechanical advantage and will stop/not open too wide.

Grip-Narrow:

- The depth of the countersink must ensure the fastener heads will not protrude in a maximum height condition;
- The holes are located such that the fasteners can also be installed (machine screws allow for a wide tolerance); and
- The width of the flange must be such that it will fit on top of the Jaw-Narrow in a maximum width condition.

Jaw-Wide:

- The axial line for the pivot hole must be held to allow the insertion of the pivot;

- The width of the jaw must be such that it will properly nest outside of Jaw-Narrow when assembled but still remove staples at a standard width; and
- The height of the pivot hole must be located such that the spring will have mechanical advantage and will stop/not open too wide.

Grip-Wide:

- The depth of the countersink must ensure the fastener heads will not protrude in a maximum height condition;
- The hole must be located such that the fasteners can be installed (machine screws allow for a wide tolerance); and
- The width of the flange must be such that it will fit on top of the Jaw-Wide in a maximum width condition.

Spring:

- The inside diameter of the coil must be such that it will fit over the pivot in a max diameter condition; and
- The length and angle of the tails must be such that the spring engages when appropriate and also restricts over-opening.

Pivot-Barrel Nut:

- Length of the barrel must be such that the pivot will function when secured in place.

Step 6. Surface finish analysis

Identify any surface finish requirements for the functional surfaces to determine if they limit any of the processes or materials selected.

Jaw-Narrow and Jaw-Wide:

- Must be smooth but not dangerous. A potential blunting may be required as driven by the material selection, but no additional polishing will be needed.

Grip-Narrow and Grip-Wide:

- Grip-Narrow and Grip-Wide: Needs to be ergonomic. If using a plastic material, no special surface finish should be required outside cleaning. If metal material is used, we may require polishing, but that will not limit the material selection overtly up front.

Spring:

- No special surface finish requirements.

Pivot-Barrel Nut:

- Head will be visible and should be aesthetically pleasing.

Step 7. Quality analysis

For the purpose of this example, assume an initial batch of 100, with 50 per month for a period of 1 year.

Within this scope, the following manufacturing processes may not be appropriate since the volumes may not support the demand quantity that is forecast.

Jaw-Narrow and Jaw-Wide:

- Remove die casting – This process and

the tooling it requires is not economic in these limited quantities;

- Remove Sand (Investment Casting) – The accuracy and surface finish demands are not compatible with this process and it is otherwise not justified by the quantities under consideration; and
- Remove Roll Forming – The small size of the parts and their required nesting over-complicates the use of this method.

Grip-Narrow and Grip-High:

- Remove metal injection moulding – this process is better suited to much higher volumes;
- Remove die casting – this process and the tooling it requires is not justified in these limited quantities;
- Remove sand (investment casting) – The tolerancing and surface finish demands do not require this process and it is otherwise not justified by the quantities under consideration; and
- Remove Extrude and Pierce – as well as all metal materials, these are no longer applicable to the grips.

Spring:

- Remove machining; and
- Highlight for Make vs. Buy decision in Step 9.

Pivot-barrel nut:

- Remove hot forming; and
- Highlight for Make vs. Buy decision in Step 9.

Step 8. Environmental analysis

This fictitious enterprise has internal targets for the life cycle carbon footprint of its products in alignment with their "green branding". This affects the following materials and processes, see Table 16:

- Remove tungsten and cobalt – The availability of home and office recycling of these materials in the UK is inconsistent and unavailable in many areas. This limits the likelihood of it being recycled in practice, giving it a High environmental impact score;
- Remove High-performance plastic, ABS and PVA/PVB – These are considered scrap plastics which can be recycled but not typically within a UK home and office recycling scheme. This

limits the likelihood of it being recycled in practice, giving it a Medium High environmental impact score for this product;

- Highlight High-density polyethylene (HDPE) – This plastic has one of the greatest recycling demands in the UK and is easier for recycling facilities to handle than other polymers. This receives a Medium to Low environmental impact score; and
- Highlight bioplastics – Bioplastics are plastic materials produced from renewable biomass instead of fossil. They are often compostable. As such, this material receives a Very Low environmental impact score.

Concept Iteration: 0

Part No.	Part Description	FA	Shape	Manufacturing Processes										Material				
				Extrude/Machine & Pierce	Stamping/Press Brake	Laser Cut/Press Brake	CNC Punch & Form	3D Printing	Cold Forming	Machining	Coiling	Plastic Moulding	Vacuum Forming	Aluminium	Steel	High density Polyethylene	Bioplastic	Make vs. Buy
1	Jaw-Narrow	A	C2	X	X	X	X	X	X			X		X	X			M
2	Grip-Narrow	A	B5	X				X				X	X			X	X	M
3	Jaw-Wide	A	C2	X	X	X	X	X				X		X	X			M
4	Grip Wide	A	B5					X				X	X			X	X	M
5	Spring	A	A2								X				X			B
6	Pivot Barrel-Nut	A	A2	X					X	X				X	X			B

Table 16. Manufacturing analysis steps 5-9 for the baseline design, concept iteration 0

Step 9. Cost analysis

The parts have had their processes and materials refined but the make vs. buy decision is not finalised. That will depend on the capability and capacity of the manufacturing facilities. Ask the supply chain to provide basic quotes to inform these choices.

Step 10. Redesign

The previous process is repeated for concept iteration 1 and two changes were identified:

- A supply chain partner advised changing the grip (both narrow and wide) to use snap-fit

connections at a similar cost. This eliminates the fastener (5.1/5.2) and makes the entire assembly much easier to disassemble at the end of life, increasing the likelihood of its individual components being recycled; and

- The jaw design (2.1/2.2 and 4.1/4.2) is modified to accommodate the above and to use a more standard size of sheet metal thickness for improved capacity at a reduced cost.

These changes resulted in the new concept iteration 2, as shown in Figure 16.

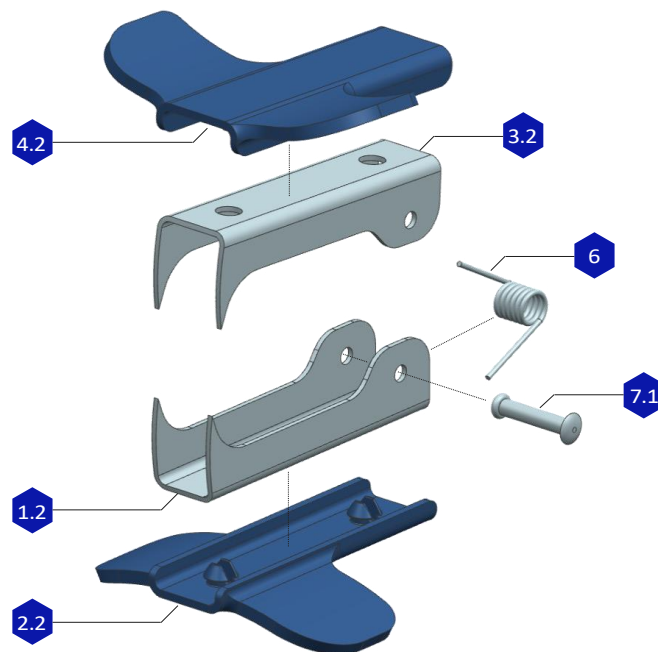

Figure 16. Staple Remover, concept iteration 2, exploded view.

Handling Analysis

Step 1. Size and weight (H_A) scoring

Assign each part a H_A score, taken from Table 2. The jaws, grips and spring are assigned a value of one. The fasteners have been scored higher as they are quite small and may require a tool for installation. The results are shown in column four of Figures 17-19.

Step 2. Handling difficulties (H_B) scoring

Assign each part a H_B score, taken from Table 3. For the staple remover's concept iterations 0-2, only the spring represents any handling difficulties due to its capacity to tangle. The results are shown in column five of Figures 17-19.

Step 3. End-to-end orientation (H_C) scoring Assign each part a H_C score, taken from Table 4. The end-to-end insertion for all components is straight-forward and easy to see and they are scored a value of 0.1, as shown in column six of Figures 17-19.

Step 4. Rotational Orientation (H_D) scoring

Assign each part a H_D score, taken from Table 5. Only the grip to jaw connections have any rotational orientation required for proper assembly and are therefore assigned a value of 0.2, as shown in Figures 17-19.

Step 5. Calculate the Handling Index for each part

The HI for each component is calculated by adding together the individual Handling scores; per Equation (2). The results are shown in the final column of Figures 17-19. Those parts with an HI larger than 1.5 have been highlighted for review.

Step 6. Calculate the overall Handling Ratio

The HR for the entire assembly is calculated using Equation (3).

The baseline concept, concept iteration 0, scores value of 2.7, exceeding the target of 2.5, indicating that potential improvements could be made (see Figure 17).

Concept iterations 1 and 2 result in significantly improved HRs, 1.9 and 1.4 respectively, as shown in Figures 18-19.

Step 7. Redesign

The design improvements implemented as a result of the Functional and Manufacturing Analyses (concept iterations 1 and 2), also provide for more efficient handling. No further iteration is deemed necessary at this time.

Part No.	Part Description	FA	H _A	H _B	H _C	H _D	HI
1	Jaw-Narrow	A	1	0	0.1	0	1.1
2	Grip-Narrow	A	1	0	0.1	0.2	1.3
5	Threaded Fastener	B	1.5	0	0.1	0	1.6
5	Threaded Fastener	B	1.5	0	0.1	0	1.6
3	Jaw-Wide	A	1	0	0.1	0	1.1
4	Grip-Wide	A	1	0	0.1	0.2	1.3
5	Threaded Fastener	B	1.5	0	0.1	0	1.6
5	Threaded Fastener	B	1.5	0	0.1	0	1.6
6	Spring	A	1	0.8	0.1	0	1.9
7	Pivot Barrel Nut	A	1.5	0	0.1	0	1.6
8	Pivot Threaded Fastener	B	1.5	0	0.1	0	1.6

$$\begin{aligned}
 HR &= \frac{\sum HI}{N_A} \\
 &= \frac{16.3}{6} \\
 &= 2.7
 \end{aligned}$$

Figure 17. Handling analysis results for the baseline design, concept iteration 0

Part No.	Part Description	FA	H _A	H _B	H _C	H _D	HI
1	Jaw-Narrow	A	1	0	0.1	0	1.1
2	Grip-Narrow	A	1	0	0.1	0.2	1.3
5	Rivet	B	1.5	0	0.1	0	1.6
3	Jaw-Wide	A	1	0	0.1	0	1.1
4	Grip-Wide	A	1	0	0.1	0.2	1.3
5	Rivet	B	1.5	0	0.1	0	1.6
6	Spring	A	1	0.8	0.1	0	1.9
8	Pivot Rivet	A	1.5	0	0.1	0	1.6

$$\begin{aligned}
 HR &= \frac{\sum HI}{N_A} \\
 &= \frac{11.5}{6} \\
 &= 1.9
 \end{aligned}$$

Figure 18. Handling analysis results for concept iteration 1

Part No.	Part Description	FA	H _A	H _B	H _C	H _D	HI
1	Jaw-Narrow	A	1	0	0.1	0	1.1
2	Grip-Narrow	A	1	0	0.1	0.2	1.3
3	Jaw-Wide	A	1	0	0.1	0	1.1
4	Grip-Wide	A	1	0	0.1	0.2	1.3
6	Spring	A	1	0.8	0.1	0	1.9
8	Pivot Rivet	A	1.5	0	0.1	0	1.6

$$\begin{aligned}
 HR &= \frac{\sum HI}{N_A} \\
 &= \frac{8.3}{6} \\
 &= 1.4
 \end{aligned}$$

Figure 19. Handling analysis results for concept iteration 2

Assembly Analysis

Step 1. Create an Assembly Sequence flowchart
 Create a flowchart for the operations required to assemble the baseline design, concept iteration 0. The operations identified for this design are as follows (as shown in Figure 20):

Sub-Assembly-Jaw, Narrow

- Select Jaw-Narrow;
- Place Grip onto Jaw;
- Secure with screw (x2);

- Repeat for Sub-Assembly-Jaw, Wide;
- Fit Sub-Assembly-Jaw, Narrow to Sub-Assembly-Jaw, Wide;
- Install Spring;
- Insert Pivot-Barrel Nut;
- Secure Pivot-Threaded Fastener; and
- Check pivot functionality.

Part No.	Part Description	FA	HI
1	Jaw-Narrow	A	1.1
2	Grip-Narrow	A	1.3
5	Threaded Fastener	B	1.6
5	Threaded Fastener	B	1.6
3	Jaw-Wide	A	1.1
4	Grip-Wide	A	1.3
5	Threaded Fastener	B	1.6
5	Threaded Fastener	B	1.6
6	Spring	A	1.9
7	Pivot Barrel Nut	A	1.6
8	Pivot Threaded Fastener	B	1.5

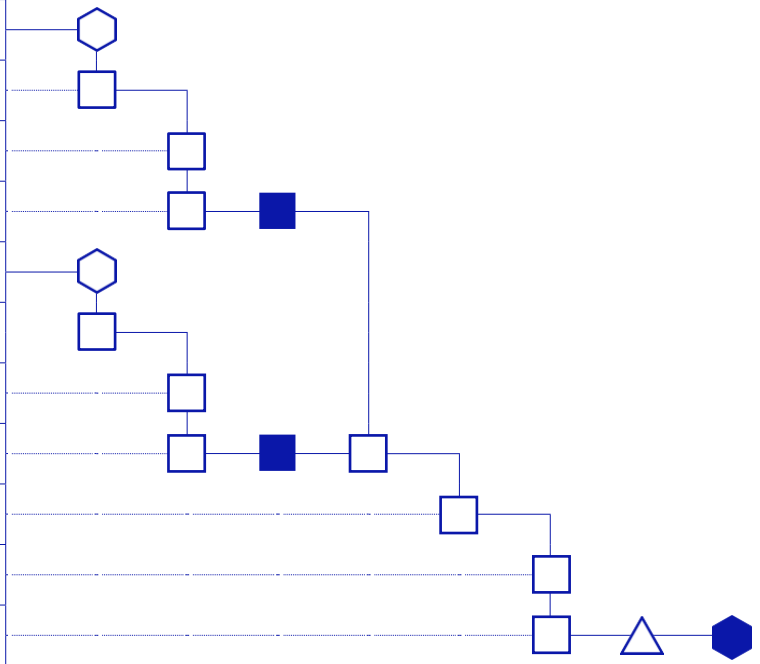

Key

<p> Work Handling (Manual)</p> <p> Assembly Process (Fitting, Fixing, Insertion)</p> <p> Mechanical Gripping</p>	<p> Secondary Operation</p> <p> Disassembly (for Tool insertion)</p> <p> Reassembly (for Tool removal)</p>	<p> Sub-Assembly Total</p> <p> Assembly Total</p>
--	--	---

Figure 20. Assembly sequence flowchart for baseline design, concept iteration 0, shown in progress

Step 2. Work handling scoring

The only work handling operations in any of the designs (concept iterations 0-2) are the part selection of base parts, which score a value of zero. This value is transferred to the flowchart and placed inside the associated circle.

Step 3. Secondary operations scoring

The only secondary operation required of concept iteration 0 is a check that the hinge functions properly. This lies somewhere in the 'reorientation' or 'take simple measurement' category; either way it is scored with a value of 1.5. That value is transferred to the flowchart and placed inside the associated triangle.

The riveted pivot assemblies (concepts 1 and 2) will deviate slightly in that they require a spacer to be inserted prior to the rivet being deformed and then removed to ensure that the pivot is neither too tight nor too loose. This results in two secondary operations being applied to the assembly sequence flowchart, as shown in Figure 21.

Concept Iteration 0

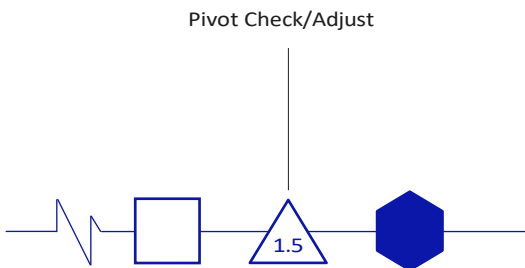

Concept Iteration 1 & 2

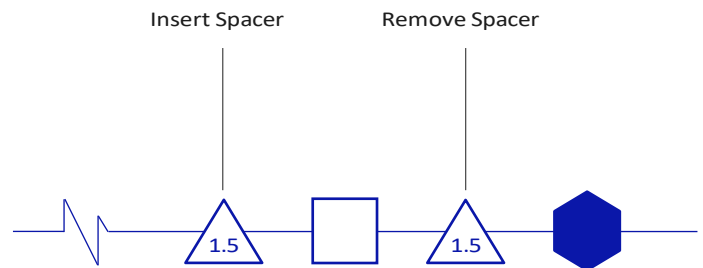

Figure 21. Secondary operation examples

Step 4. Determine the Fitting Index (FI) for each assembly process

Calculate the FI for each operation in the flowchart (indicated by a square). Assign the appropriate fitting scores (F_A through F_F) for each operation then add those values together. The results for the baseline design, concept iteration 0, are shown in Table 17. These values are then transferred to the flowchart and placed inside the associated squares (see Figures 22-24).

Step 5. Calculate the sub-assembly and overall assembly totals

Calculate the sub-assembly and assembly totals, and add them to the flowchart inside the double-lined circle or rectangle, as appropriate. See Figures 22-24 for an example of this in practice.

Part No.	Part Description	Assembly Operation	Placement	F_{A1}	Fastening	F_{A2}	Process Direction	F_B	Process Type	F_C	Access	F_D	Alignment	F_E	Force	F_F	FI
1	Jaw-Narrow																
2	Grip-Narrow		Requires holding	2	-	0	Straight line from above	0	-	0	Direct access	0	Difficult to align	0.7	No resistance	0	2.7
5	Threaded Fastner		Requires holding	2	Screwing	4	Straight line from above	0	Single insertion	0	Direct access	0	Easy to align	0	No resistance	0	6
5	Threaded Fastner		Requires holding	2	Screwing	4	Straight line from above	0	Single insertion	0	Direct access	0	Easy to align	0	No resistance	0	6
	Sub-Assembly Narrow																
3	Jaw-Wide																
4	Grip-Wide		Requires holding	2	-	0	Straight line from above	0	-	0	Direct access	0	Difficult to align	0.7	No resistance	0	2.7
2.7	Threaded Fastner		Requires holding	2	Screwing	4	Straight line from above	0	Single insertion	0	Direct access	0	Easy to align	0	No resistance	0	6
5	Threaded Fastner		Requires holding	2	Screwing	4	Straight line from above	0	Single insertion	0	Direct access	0	Easy to align	0	No resistance	0	6
	Sub Assy, Wide																
	Sub Assy, Narrow to Sub-Assy Wide		Requires holding	2	-	0	Straight line from above	0	Single insertion	0	Direct access	0	Easy to align	0	No resistance	0	2
6	Spring		Requires holding	2	-	0	Straight line from another direction	0.1	Single insertion	0	Direct access	0	Difficult to align	0.7	Resistance to insertion	0.6	3.4
7	Pivot-Barrel Nut		Self-locating	1	-	0	Straight line from another direction	0.1	Single insertion	0	Direct access	0	Difficult to align	0.7	No resistance	0	1.8
8	Pivot-Threaded		Self-locating	1	Screwing	4	Straight line from another direction	0.1	Single insertion	0	Direct access	0	Easy to align	0	No resistance	0	5.1

Table 17. FI calculation for baseline design, concept iteration 0, assembly processes.

Step 6. Calculate the Assembly Ratio (AR)

Calculate the AR for the entire assembly using Equation (6). The baseline design, concept iteration 0, scores a value of 7.2, exceeding the target of 2.5, indicating that potential improvements could be made (see Figure 21).

Step 7. Redesign

Repeat the process for concept iterations 1 and 2. This results in ARs of, 4.9 and 3.6 respectively, as shown in Figures 22-23. This is a significant improvement, but it is still shy of the target, indicating more might be done to further optimise assembly.

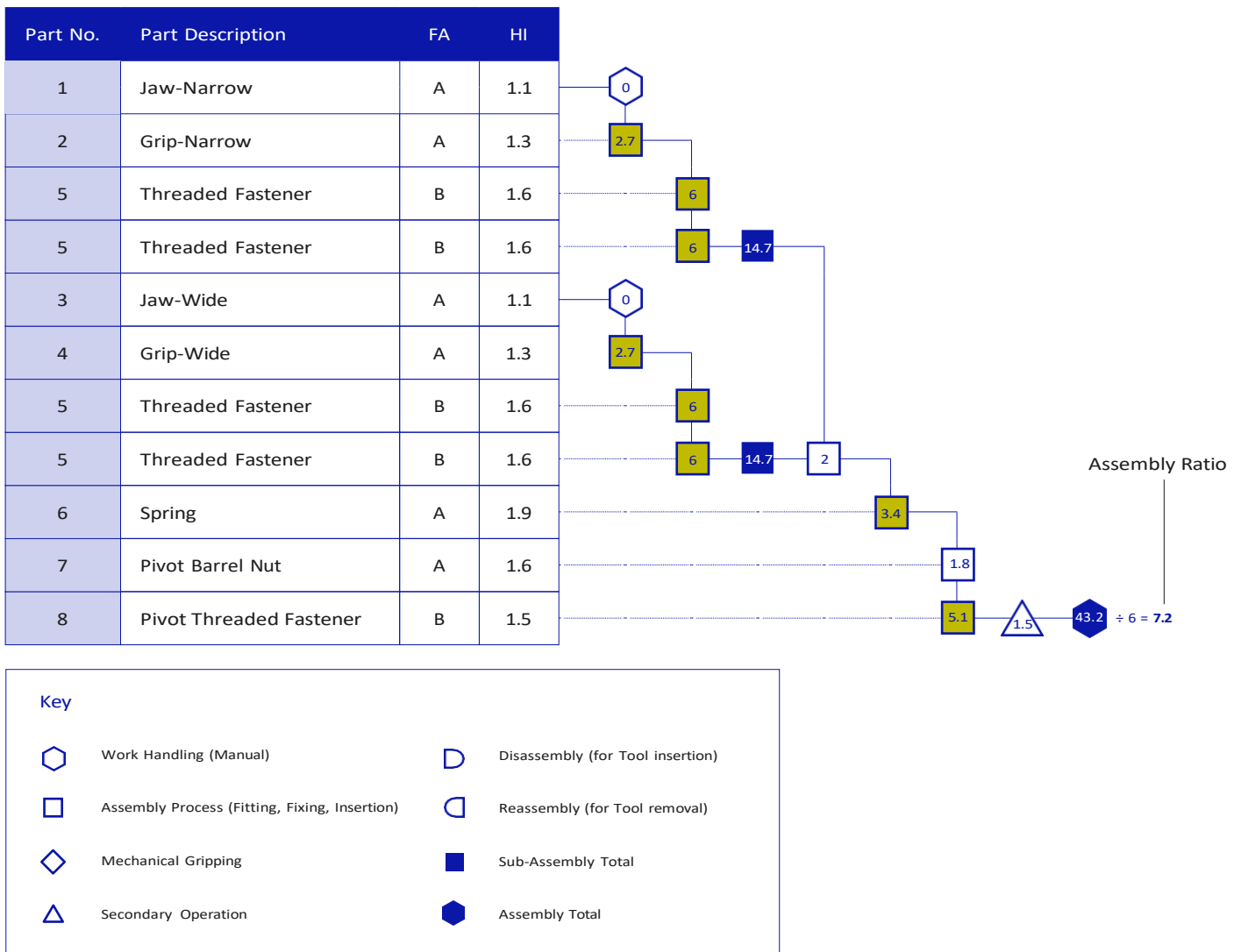

Figure 22. Completed assembly sequence flowchart for baseline design, concept iteration 0



Figure 23. Completed assembly sequence flowchart for concept iteration 1

Step 8. Iterate

Scrutinise previous approaches and challenge some early assertions:

- Could the rivet gun be fitted with a pre-loaded set of rivets to improve the time taken, part handling, and ease of assembly for the pivot?;
- Could the coiled spring be replaced with a flat spring?; and
- What other changes could be made to meet the initial brief but further optimise the assembly?

It is important to remember that the targets provided in this guide are not set in stone, but rules of thumb designed to encourage discussion and thoughtful exercise. The process highlights possible optimisations within a design that have the

opportunity to dramatically improve its ability to manufacture and fit into a final assembly (reducing overall cost) but it also encourages ‘out of the box’ thinking. As such, the real value lies in engaging in the process and making conscious decisions in the development of any product.

With that said, this process resulted in the concept iteration 3 (as depicted in Figure 24) as another potential concept. This design offers an alternative that is dramatically easier to produce and still meets the product’s fundamental requirements. This shape indicates a moulded, cast or additive manufactured base part with a handle dipped in a rubberised vinyl, the exact material and manufacturing methods to be driven by the expected volumes else iterated upon further.

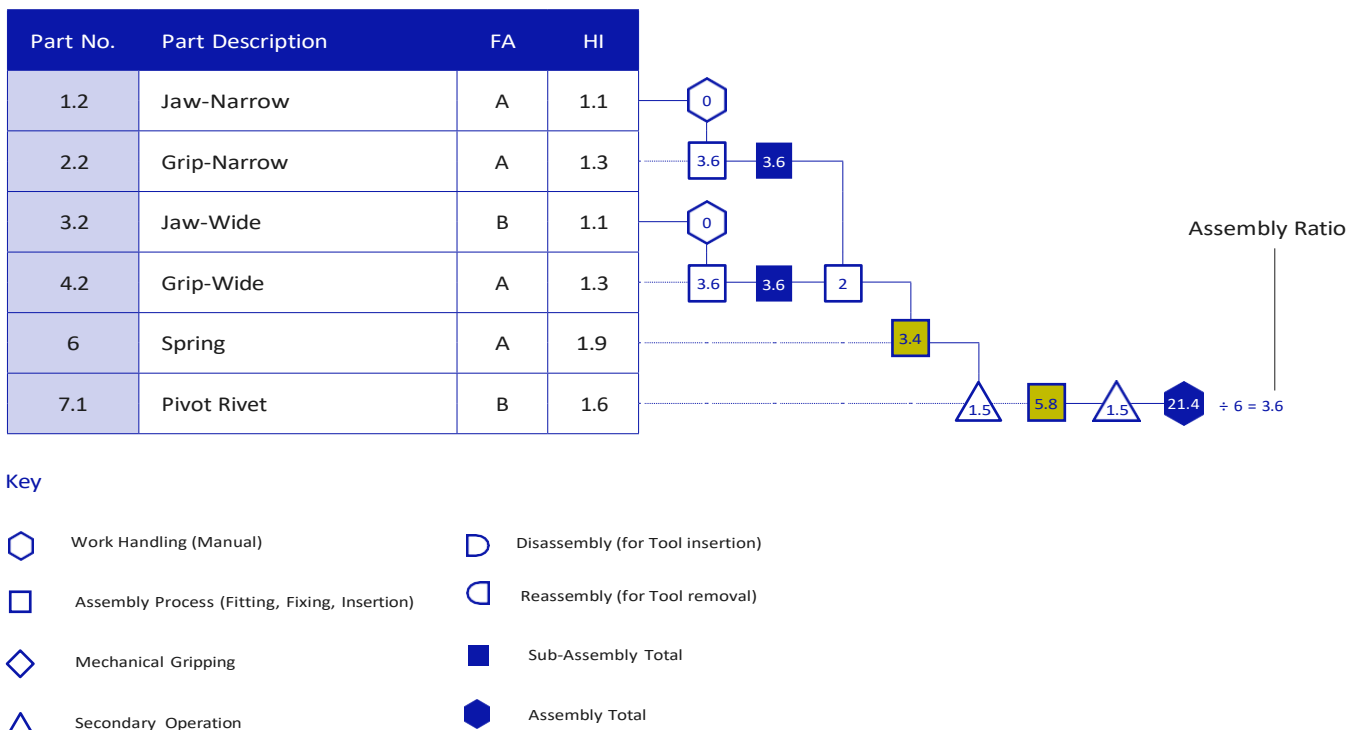

Figure 24. Completed assembly sequence flowchart for concept iteration 2

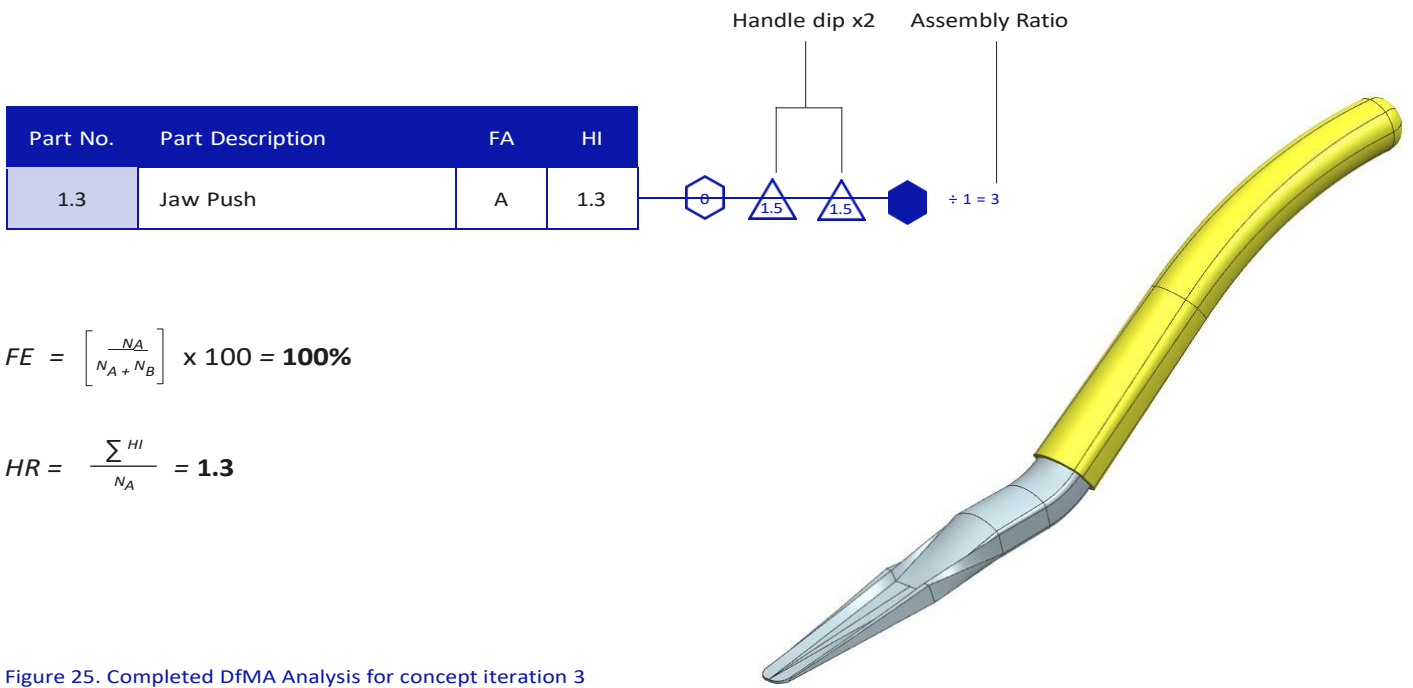

Figure 25. Completed DfMA Analysis for concept iteration 3

References and Appendices

References

- [1] Lucas Engineering & Systems Ltd and University of Hull. (1994) Design for manufacture: Reference tables (Version 10). Solihull, UK: Lucas Industries.
- [2] Boothroyd, G., Dewhurst P. & Knight, W. (2011). Product design for manufacture and assembly (3rd Ed.). Boca Raton, FL: CRC Press.
- [3] The Manufacturing Technology Centre. (2016). Transforming performance and productivity in the construction industry. Coventry, UK: The Manufacturing Technology Centre
- [4] Swift, K. G. & Booker, J. D. (2003). Process selection: From design to manufacture (2nd ed.). Oxford, UK: Butterworth-Heinemann.
- [5] Health and Safety Executive, Manual handling at work: A brief guide (INDG143). (Rev.4). (2020). London, UK: HMSO.
- [6] Swift, K. G. & Miles, B. L. (1985). Design for assembly, Volume 2. Solihull, UK: Lucas Engineering & Systems Ltd.
- [7] Leaney, P. G. (1996). Case experience with design for assembly methods. In Huang, G. Q. (Ed.). Design for X: Concurrent engineering imperatives, (pp. 41-71). London, UK: Chapman & Hall.
- [8] Automotive Industry Action Group. (2008). Advanced product quality planning (APQP) and control plan reference manual (2nd ed.). Southfield, MI: Automotive Industry Action Group
- [9] Tanner, S. & Bailey, M. (2014). The business improvement handbook (4th ed.). London, UK: BSI Group.
- [10] Society of Automotive Engineers. (2016). Aerospace Series – Requirements for advanced product quality planning and production part approval process. AS9145. Society of Automotive Engineers.
- [11] British Standards Institution. (2017). Buildings and civil engineering works – vocabulary. Part 2: Contract and communication terms. BS ISO 6707-2. British Standards Institution.

Appendices

Appendix A – DfMA Worksheet

The following is an adaptation of the worksheet developed by Lucas Engineering & Systems Ltd for DfMA hand calculations [1], to be used within the context of this guideline. This template is intended to aid the process of using Design for Manufacture and Assembly (DfMA) independent of any specific software solution.

Templates to be used within the context of this guideline are available, please contact: cpqp@constructioninnovationhub.org.uk

Appendix B – List of Abbreviations

The following is a list of initialisations and acronyms used in this guideline.

0-9	2D	Two-dimensional
	3D	Three-dimensional
A	APQP	Advanced Product Quality Planning
C	CPQP	Construction Product Quality Planning
D	DfMA	Design for Manufacture and Assembly
	DFMEA	Design Failure Mode Effects Analysis
F	FE	Functional Design Efficiency
	FMEA	Failure Mode and Effects Analysis
H	HR	Handling Ratio
P	PFMEA	Process Failure Mode Effects Analysis
Q	QFD	Quality Functional Deployment

Appendix C – Glossary of Terms

The following is a list of commonly utilised quality, manufacturing and construction specific terms and their definitions within this context used within this guideline.

- A** Advanced Product Quality Planning (APQP)
A quality framework used for developing new products. It was developed by the automotive industry but can be applied to any industry and is similar in many respects to the concept of design for Six Sigma methodology [8].
- C** Construction Product Quality Planning (CPQP)
An adaptation of Advanced Product Quality Planning (APQP) [9] that is aimed at those enterprises that will feed construction with new componentry for offsite builds.
- D** Design Failure Mode Effects Analysis (DFMEA)
An application of Failure Mode Effects Analysis (FMEA) for product design.

Design for Manufacture and Assembly (DfMA)
Product design with design priority given to ease of both assembly and manufacture.
- F** Failure Mode Effects Analysis (FMEA)
'A tool for facilitating the process of predicting failures, planning preventative measures, estimating the cost of the failure, and planning redundant systems or system responses to failures' [9]. 'The FMEA assists in the identification of CIs as well as key design and process characteristics, helps prioritise action plans for mitigating risk and serves as a repository for lessons learned' [10].
- P** Process Failure Mode Effects Analysis (PFMEA)
An application of Failure Mode Effects Analysis (FMEA) for process design and implementation.
- T** three-dimensional (3D)
BS ISO 6707-2: 'Having or seeming to have length, width and depth.' [11].

two-dimensional (2D)
BS ISO 6707-2: 'Having or seeming to have two dimensions, such as width and height but no depth.' [11].
- Q** Quality Functional Deployment (QFD)
A structured approach to defining customer needs and translating them into specific product development plans. particular organisation and includes the positive benefits that voice can bring to an organisation, for example, improved innovation.

Disclaimer

This disclaimer governs the use of this publication and by using this publication, you accept the terms of this disclaimer in full. The information contained within this publication does not constitute the provision of technical or legal advice by the Construction Innovation Hub or any of its members and any use made of the information within the publication is at the user's own discretion. This publication is provided 'as is' and neither the Construction Innovation Hub nor any of its members accept liability for any errors within this publication or for any losses arising out of or in connection with the use or misuse of this publication. Nothing in this disclaimer will exclude any liability which cannot be executed or limited by law.

The Construction Innovation Hub is funded by UK Research and Innovation through the Industrial Strategy Challenge Fund



The Construction Innovation Hub is a consortium between:

