

THE PRODUCT PLATFORM RULEBOOK

THE RULES & PRINCIPLES

THE RULES

THE PRINCIPLES



1. DEPLOYABLE



2. CONFIGURABLE



3. COMMON
REPEATABLE
ELEMENTS



4. INTERFACES



5. OPEN



6. QUALITY



7. STRUCTURED
INFORMATION



8. CIRCULAR

FOREWORD

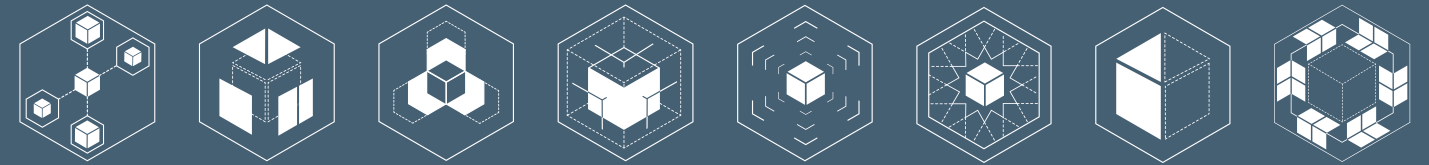

Infrastructure and Projects Authority

Government has made clear its intent to deliver better societal outcomes from the interventions that it makes in the built environment. Since 2018 the Construction Innovation Hub, funded from UK Research and Innovation's Industrial Strategy Challenge Fund, and with significant contributions from over 300 partners from industry and government, has focused on enabling this transformation.

In line with this aim, the Product Platform Rulebook has been developed to support the implementation of the policies described in the Construction Playbook and enable the accelerated adoption of platform approaches as described in Transforming Infrastructure Performance: Roadmap to 2030 (TIP).

The Platform programme has focused on adapting and developing manufacturing approaches that will improve productivity whilst shifting focus to quality, performance and the whole-life value of assets. Platform approaches represent a fundamental change, requiring different behaviours from both the client and the supply chain, and enabling outcomes not just at the level of individual projects or programmes, but at a societal level, for example by creating more inclusive employment.

The Hub weaves together the Platform programme with three other connected themes to create a suite of enabling mechanisms for change. The Value Toolkit is driving a permanent shift towards value-based decision-making; the Information Management projects have enabled organisations and governments to realise the benefit of digital transformation and the International programme established opportunities for an open and digitalised global construction market.

The Rulebook is an open-access guide to key processes giving industry the tools they need to invest in their capability to develop product platforms and build their capacity to respond to an aggregated pipeline. In turn, clients will be enabled to specify a platform approach with confidence – secure in the knowledge that it will enhance safety, performance and quality standards.

During the development journey, [Defining the Need](#), published by the Hub in January 2021, identified the extensive market opportunity for platform construction systems across social infrastructure. This Rulebook takes accounts of those findings and following extensive industry consultation and engagement, offers not just 'The Rules' – a guiding set of principles that should be followed to develop a valid product platform – but also the Product Platform Development Framework – a common framework of approaches to guide anyone seeking to develop and deploy product platforms. This, along with detailed guidance, links to related research and supporting materials, is underpinned by tangible case studies, involving proof of concepts, flagship projects and solutions to demonstrate the applications in real world projects championed by leading industry players.

This Rulebook stands ready to be the blueprint for developing and implementing product platforms for current and future market players. Designed with built-in mechanisms for continuous improvement and future opportunities for harmonisation and rationalisation as capability and capacity grows. The work involved in getting to this point shows the power of effective collaboration and the commitment of the organisations involved to work together – tackling common industry challenges for the benefit of all.

Produced by industry, for industry and always in step with government policy.

With the publication of this first edition of the Rulebook, I hope that the industry will seize the opportunity, continue to collaborate, and use it as the basis for transforming construction for the future, creating sustainable, productive and profitable businesses, and successful projects that deliver real value.

Nick Smallwood, Chief Executive Officer of the Infrastructure and Projects Authority and Head of the Government's Project Delivery Function

CONTENTS

1. FUNDAMENTALS	6	4. RECOMMENDATIONS	53
1.1. Policy context	6	4.1. Recommendations	53
1.2. Rulebook overview	8		
WHAT IS THE PURPOSE OF THE RULEBOOK?	8		
RULEBOOK STRUCTURE	8		
1.3. Platform fundamentals	10	5. LEGACY	54
WHAT IS A PLATFORM?	10	5.1. Legacy principles	54
WHAT IS A PRODUCT PLATFORM?	11	RULEBOOK LEGACY	54
PLATFORMS IN CONSTRUCTION	13	KEY PRINCIPLES AND EXPECTATIONS	54
BENEFITS OF PLATFORMS	14	DEFINING KEY ROLES	54
CHALLENGES	15		
INTELLECTUAL PROPERTY AND LIABILITY	16	6. BEST PRACTICE	55
THE TRANSFORMATION	17	6.1. Case studies	55
		CASE STUDY: THE SEISMIC PLATFORM	56
2. THE RULES	19	CASE STUDY: PLATFORM II	58
2.1. Scope	19	CASE STUDY: GENZERO - DEPARTMENT FOR EDUCATION	59
2.2. Distinction between Rules and Principles	19	CASE STUDY: HIGH RISE SOLUTIONS (HRS)	60
2.3. Rules and Principles	20	CASE STUDY: NG BAILEY – M&E KIT OF PARTS AT THE FORGE, LONDON	61
		6.2. GUIDANCE ON CIRCULARITY	62
3. GUIDANCE	22	CIRCULAR DESIGN PRINCIPLES	63
3.1. How the industry must change to enable product platforms	23	Sustainable Design	
CLIENT DOMAIN	23	Circular Design	
PROJECT DOMAIN	23	Virgin or Primary Materials	
PRODUCT DOMAIN	23	Non-Virgin or Secondary Materials	
SUMMARY OF THE CURRENT STATE	24	Closing the Loop	
FUTURE STATE ENABLERS	24	Materials Passports	
SUMMARY OF THE FUTURE STATE	24	Buildings as Material Banks - Materials Passports	
3.2. Product Platform Development Framework	24	Design for 'X'	
3.3. Product Platform Development	27	6.3. Further reading	66
INPUTS FROM THE CLIENT DOMAIN	27	Policy	
PRODUCT PLATFORM STRATEGY	28	Product Platforms IN CONSTRUCTION	
Strategic intent		Platform Thinking	
Market segmentation		Construction Innovation Hub Outputs	
Commonality strategy			
Develop outline business case			
PRODUCT PLATFORM PLANNING	38		
Design enterprise architecture			
Benchmark existing solutions			
Generate concept(s)			
Develop platform performance specification			
PRODUCT PLATFORM DESIGN	47		
Design kit of parts and interface definition			
Design production process (and assembly)			
Design assurance regime			
Develop deployment manual			
		7. DEFINITIONS	67

FIGURES

Fig. 1A: <i>The Policy Landscape</i>	6	Fig. 3J: <i>Ranking systems by their influence and contribution to project cost</i>	32
Fig. 1B: <i>How the Rulebook fits within the TIP Built Environment model</i>	7	Fig. 3K: <i>The aims, benefits and risks from commonality</i>	34
Fig. 1C: <i>Product Platform Development Framework Structure & Navigation Aid</i>	9	Fig. 3L: <i>Key factors to a successful commonality strategy</i>	35
Fig. 1D: <i>Platform shoes</i>	10	Fig. 3M: <i>Cause-effect relationships for a PPP delivering 3 unique frame systems across 3 projects</i>	36
Fig. 1E: <i>The kitchen cabinet</i>	11	Fig. 3N: <i>Product Platform Planning</i>	38
Fig. 1F: <i>Platform Terminology</i>	12	Fig. 3O: <i>Information systems,</i>	39
Fig. 1G: <i>Examples of platforms within construction industry</i>	13	Fig. 3P: <i>Suggested benchmarking workflow</i>	40
Fig. 1H: <i>Benefits of platforms</i>	14	Fig. 3Q: <i>Design Structure Matrices and QFD</i>	41
Fig. 1I: <i>Expectations of product platforms</i>	15	Fig. 3R: <i>How commonality, variety and interfaces can be visualised</i>	42
Fig. 1J: <i>Intellectual property, ownership and liability considerations</i>	16	Fig. 3S: <i>Hypothetical Coupling Index Matrix</i>	43
Fig. 1K: <i>Common repeatable, complementary, and bespoke elements</i>	17	Fig. 3T: <i>Identifying areas of focus using cost and importance of variety</i>	44
Fig. 1L: <i>Adapted from Nadadur et al, 2012 'Strategic Product design for Multiple Global Markets'</i>	17	Fig. 3U: <i>Identifying areas of focus using commonality and variety</i>	44
Fig. 1M: <i>Conditions for success and challenge</i>	18	Fig. 3V: <i>Mapping sensitivity and connectivity</i>	45
Fig. 2A: <i>The rules and principles</i>	21	Fig. 3W: <i>Product Platform Design</i>	47
Fig. 3A: <i>The three steps of the Develop stage of the Product Platform Development Framework</i>	22	Fig. 3X: <i>Example of measuring the part count efficiency of an assembly</i>	48
Fig. 3B: <i>Current State</i>	24	Fig. 3Y: <i>Example of classifying the complexity of a product to determine the complexity of its process</i>	49
Fig. 3C: <i>Future State</i>	24	Fig. 3Z: <i>Deployment manual development aligned to RIBA DfMA workstages</i>	51
Fig. 3D: <i>Aspirations of the New Hospital Programme</i>	24	Fig. 5A: <i>Venn diagram demonstrating key principles and their interaction</i>	54
Fig. 3E: <i>Product Platform Development Framework aligned to the three domains</i>	25	Fig. 6A: <i>Application of the Product Platform Rules and Principles to Seismic II</i>	57
Fig. 3F: <i>The core steps and activities underpinning the development of a product platform strategy</i>	28	Fig. 6B: <i>The Value Toolkit with the four capitals</i>	62
Fig. 3G: <i>Using a DSM to define Interfaces with other systems</i>	29	Fig. 6C: <i>Moving from a linear to a circular economy CE Hub</i>	63
Fig. 3H: <i>Three possible models for a product platform in construction.</i>	30	Fig. 6D: <i>The Circular Economy</i>	64
Fig. 3I: <i>A selection of segmentation grids, covering different lenses for different PP types</i>	31		

About the Construction Innovation Hub: Funded by Government in 2018 with £72 million from UK Research and Innovation's Industrial Strategy Challenge Fund, the Construction Innovation Hub brings together world-class expertise from BRE, the Centre for Digital Built Britain (CDBB) at the University of Cambridge and the Manufacturing Technology Centre (MTC). We're a market enabler. Our main role is to enable transformation through collaboration. We are working with over 300 partners in government, industry and academia to develop outputs that are driving efficiency and quality in construction manufacturing and delivery so that our built environment is fit for the future. We share a vision for a built environment that deliver better outcomes for current and future generations. Businesses of all size stand ready to meet the UK's future construction and infrastructure needs and to achieve this vision we must continue to develop these solutions, to embed them at scale, and to build capability and capacity in both clients and industry.

Together, we're transforming construction.

For further details about the Construction Innovation Hub, please contact: info@constructioninnovationhub.org.uk
www.constructioninnovationhub.org.uk

Disclaimer: This disclaimer governs the use of this publication and by using this publication, you accept the terms of this disclaimer in full. The information contained within this publication does not constitute the provision of technical or legal advice by the Construction Innovation Hub or any of its members and any use made of the information within the publication is at the user's own discretion. This publication is provided "as is" and neither the Construction Innovation Hub nor any of its members accept liability for any errors within this publication or for any losses arising out of or in connection with the use or misuse of this publication. Nothing in this disclaimer will exclude any liability which cannot be executed or limited by law.

1. FUNDAMENTALS

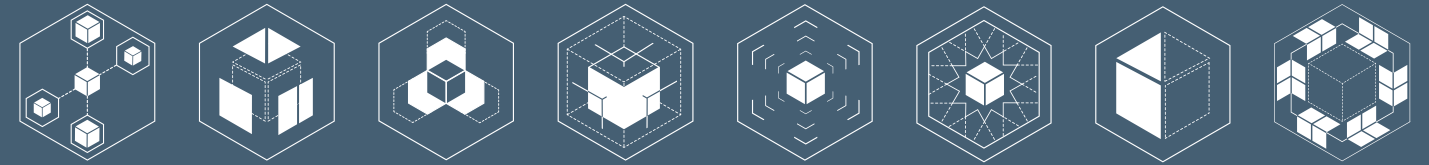

“Since most companies design new buildings one at a time, the focus on individual schemes results in a failure to embrace commonality, standardisation or compatibility across projects or programmes of work”

Adapted from Meyer & Lenherd (1997)

The Platform Programme and this Rulebook were first conceived as a response to growing recognition that a platform-based approach can help the construction sector to deliver better outcomes by working in a more productive, sustainable and socially inclusive way, as we seek to create a better built environment.

The challenges and obstacles faced by the industry have been regularly documented and analysed over many years; hard-hitting publications such as [Modernise or Die](#) have reaffirmed a clear case for change. Recent shifts in the socio-economic landscape have only added to the urgent need for a systematic step-change in how and what the industry delivers.

Seeking to catalyse transformative change, the UK government has demonstrated unprecedented levels of support and commitment to both Modern Methods of Construction (MMC) and a Platform approach to Design for Manufacture and Assembly (P-DfMA).

Through the use of **platforms** - common, repeatable assets with interoperable components - it aims to drive a new market for manufacturing in construction, to provide a predictable pipeline of demand that affords industry the confidence to invest in new products and technologies and to create stable and inclusive employment where jobs are most needed.

To achieve this vision requires the development of new skills, new ways of works and collaboration, both across and within organisations. The Rulebook supports this transformation, by accelerating the awareness and understanding of product platforms, whilst facilitating a common process of development, that can be applied consistently across industry.

1.1. Policy context

As the single largest construction client, Government is focused in using its position to support the adoption of a more productive and sustainable business model within the UK construction sector.

Policy released over recent years reflects this ambition: promoting the use of a platform approach to drive improved productivity, innovation, efficiency and reduce carbon emissions in the construction and infrastructure sectors. With the [industry consultation](#) on the use of platforms coinciding with the pandemic and fundamental shifts in broader society, the drivers and momentum behind the use of platforms have rapidly grown.

In that vein, the [Construction Playbook](#), published in 2020 and founded on a comply or explain basis, embeds product platforms at the core of its MMC policy.

“We [the Government] will look to procure construction projects based on product platforms comprising of standardised and interoperable components and assemblies”.

Construction Playbook (UK Cabinet Office)

- 2017**
 - “Presumption in favour of offsite” (Budget speech)
 - Transforming Infrastructure Performance (IPA)
- 2018**
 - Hackitt Review
 - Offsite Manufacture for Construction (House of Lords)
- 2019**
 - Presumption in favour of offsite (where it affords best value for money)
- 2020**
 - Environment Bill
 - PPN06/20 – Taking account of social value
 - Future Buildings Standard consultation
 - Construction Playbook (Cabinet Office)
 - P-DfMA Summary of Evidence (IPA)
 - National Infrastructure Strategy (HMT)
 - Dasgupta Review Response (HMT)
 - Planning for the Future white paper (MHCLG)
- 2021**
 - Building Safety Bill (MHCLG)
 - Construction Product Regulation
 - Fire Safety Act
 - PPN06/21 – Taking account of Carbon Reduction Plans
 - TIP Roadmap (IPA)
 - Heat in Buildings Strategy (BEIS)
 - Green Revolution Pledge
 - Transport Decarbonisation Plan (DfT)
 - Code for Construction Product Information
 - Morell Review into Construction Product Testing Regime
 - C02nstructZero (CLC)
- 2022**
 - **The Product Platform Rulebook**
 - Amendments to Building Regs Part F, L and addition of Part O
 - UK Digital Strategy (DCMS)
 - Levelling Up the UK (DLUHC)
 - Constructing the Gold Standard (D.Mosey)

- KEY**
- Publications & consultations (Govt. led)
 - Policy & regulations
 - Other

Fig. 1A: The Policy Landscape

Building upon the vision of the Construction Playbook, the Transforming Infrastructure Performance (TIP) – *Roadmap to 2030*, published in 2021, outlines the planned steps behind the government’s commitment to use product platforms.

The TIP Roadmap expressed how the government will, through a platform approach, “generate societal outcomes from its pipeline, by enabling a disaggregated manufacturing industry that creates stable and inclusive employment where jobs are most needed”. This includes an intent “to support a future mandate for Construction Platform approaches for relevant assets”.

“in the next two years the government will set out a requirement for platform approaches to be adopted for social infrastructure with a repeatable design”

Transforming Infrastructure Performance: Roadmap to 2030 (Infrastructure Projects Authority, 2021)

In preparing for this mandate, the TIP Roadmap acknowledges the need for adaption in culture, processes and skills, alongside development and management of core, technical elements. This Rulebook has been developed to support this path, translating policy into practice by providing a framework for the development of platforms that supports harmonisation and industry consensus of approach.

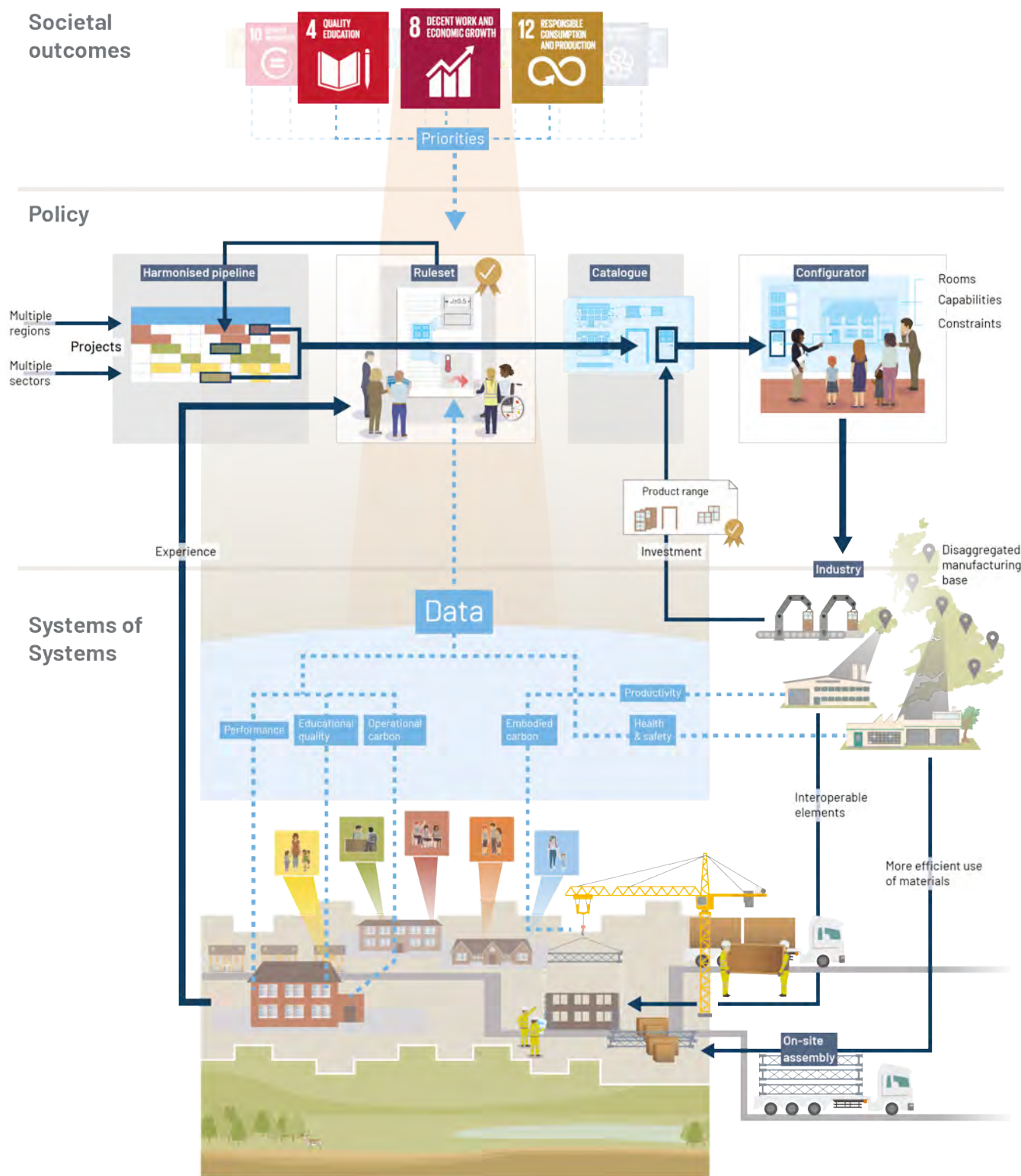

Fig. 1B: How the Rulebook fits within the TIP Built Environment model

HARMONISE, DIGITISE, RATIONALISE

The Construction Playbook contains 14 ‘key policies’ mandated for central government departments and arms-length bodies on a ‘comply or explain’ basis.

It directly states that government “will look to procure construction projects based on product platforms” and actively encourages authorities to “find opportunities not only for their own platform solutions but also for ways in which cross-sector platforms can be applied”.

The Playbook outlines an intent to ‘Harmonise, Digitise and Rationalise demand’ across individual projects and programmes “to accelerate the development and use of platform approaches, standard products and components to transform the market’s ability to plan, invest and deliver digital and offsite manufacturing technologies.”

Throughout this Rulebook you will see frequent reference to the terms “Harmonise, Digitise and Rationalise” with guidance that enables and supports this approach.

THE PRODUCT PLATFORM RULEBOOK

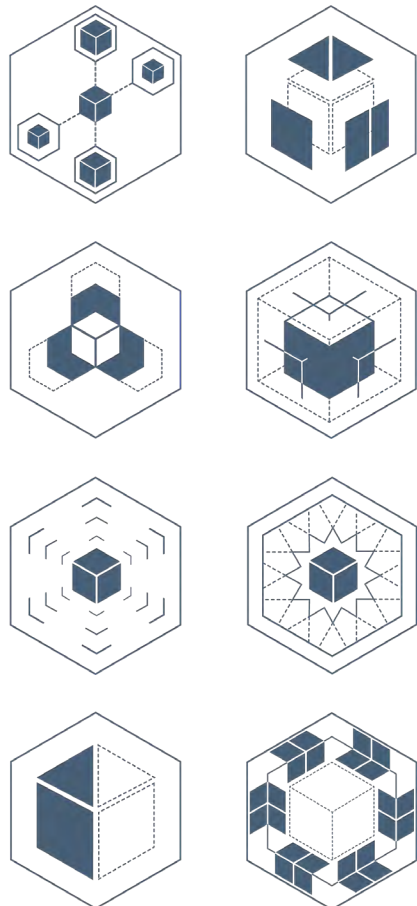

WHAT IS THE PURPOSE OF THE RULEBOOK?

The Rulebook is a fundamental step towards creating a voluntary consensus standard that supports the construction industry, as a whole, to develop and deploy product platforms consistently to deliver better environmental and societal outcomes through the built environment.

Recognising the varying familiarity readers will have with the principles of platform-based approaches, the Rulebook is structured to:

- **Educate:** to provide an introduction to the principles of product platforms
- **Empower:** to provide a framework that guides, supports and empowers those seeking to develop and/or deploy product platforms
- **Enable:** to establish rules, principles and a framework that support consistent development and deployment of product platforms, stimulating the potential for cross-platform harmonisation and cultivating market capacity to respond to an aggregated pipeline.

With this ambition the Rulebook has been written to aid the full breadth of the construction value chain, in developing knowledge, understanding, application and analysis of product platforms.

It is underpinned by a philosophy of cooperative competition, enabling a marketplace that “collaborates on standards and competes in delivery” to deliver better outcomes for society.

RULEBOOK STRUCTURE

The Rulebook has been structured as follows:

1. **FUNDAMENTALS:** An outline of the principles of product platforms, what they are and the benefits that they can bring in the construction sector.
2. **THE RULES:** A set of Rules which must be adhered to, and a set of Principles that should be followed, in order to develop a valid product platform.
3. **GUIDANCE:** (including Platform Product Development Framework) Guidance for those wanting to develop a product platform, including how to create the conditions to enable their successful use.
4. **RECOMMENDATIONS:** Actions for government and industry to continue the uptake and adoption of product platforms.
5. **LEGACY:** An outline of the planned development of a legacy strategy that supports continued development of the Rulebook, to enable and empower market actors in the longer-term.
6. **BEST PRACTICE:** Case study examples of how product platforms have been applied in practice and suggestions for further reading.
7. **DEFINITIONS:** Definitions of terms used, providing a common framework to support the development of product platforms.

You can navigate to each of these sections by using the hyperlinks at the foot of each page.

Recognising the diverse outputs and activities within the construction industry, there is significant challenge in trying to provide a rulebook that satisfies the needs of all.

This Rulebook does not detail an exhaustive set of considerations for product platforms, nor should it be read as a comprehensive deployment manual for delivering them. It does however define rules, principles and a framework which, if applied with context, will support as intended by the Construction Playbook “*the development and use of consistent, structure, rules and language to facilitate a shared understanding*”.

This is a navigation aid to the Product Platform Development Framework - click on the section you'd like to explore.

THE PRODUCT PLATFORM RULEBOOK

1. FUNDAMENTALS

2. THE RULES



3. GUIDANCE

DEMAND

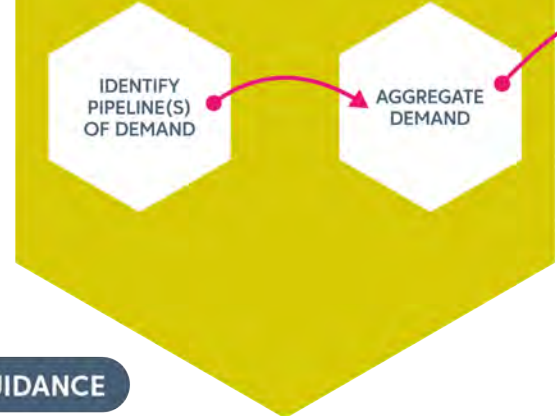

DEVELOP

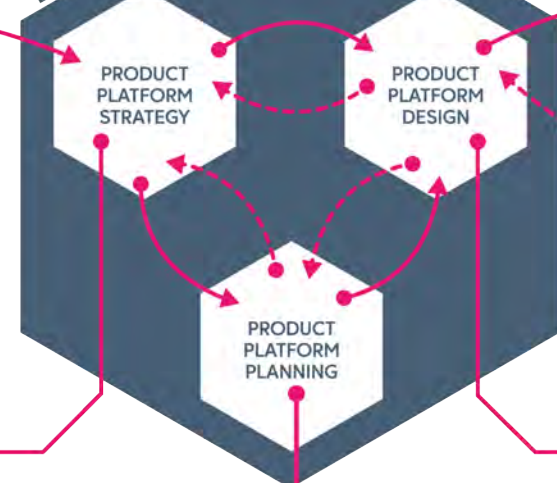

DEPLOY

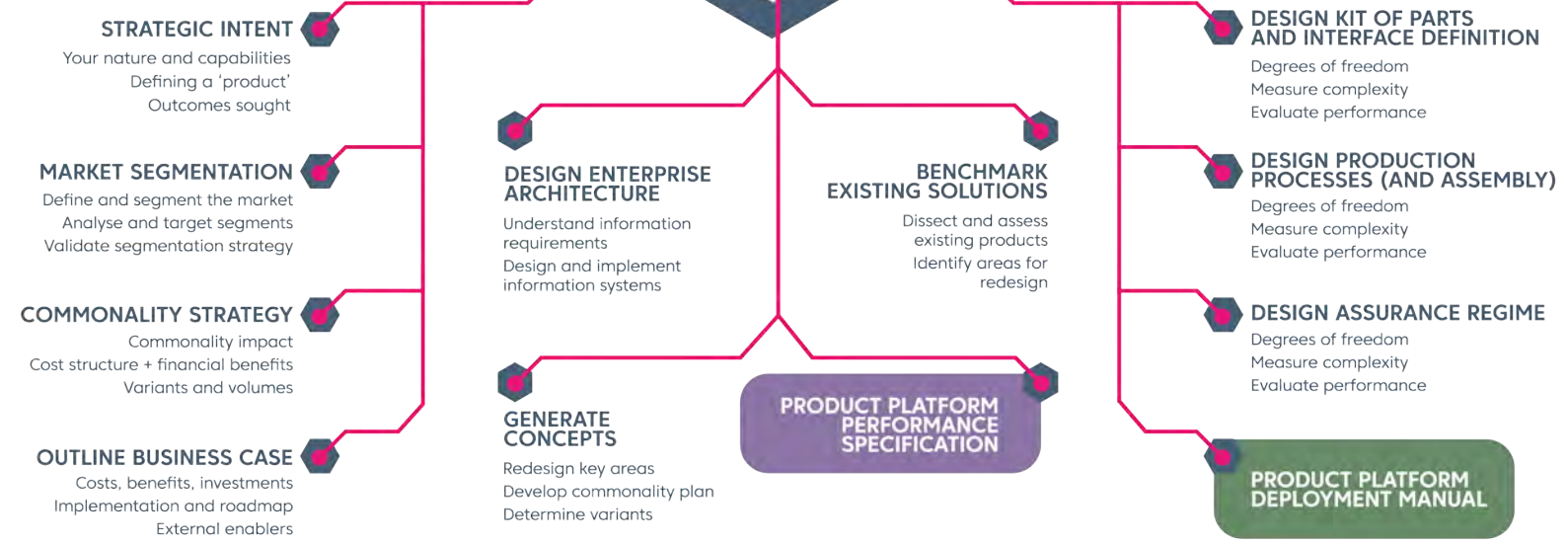
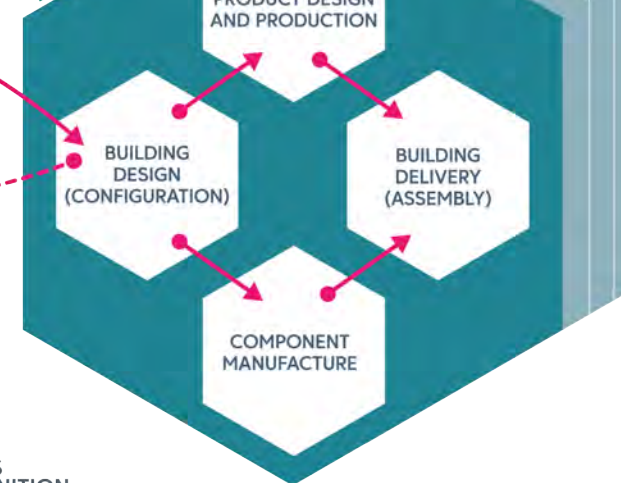

4. RECOMMENDATIONS

5. LEGACY

6. BEST PRACTICE

7. DEFINITIONS

Fig. 1C: Product Platform Development Framework Structure & Navigation Aid

1.3. Platform fundamentals

WHAT IS A PLATFORM?

The term 'platform' is used in both different contexts and at varying degrees of scale, ranging from specific products to solutions that span multiple industries. Irrespective of this diversity, platforms share several common features:

- A set of low variety common assets shared by a set of products. These 'common assets' are typically physical components, but may also include repeated processes, knowledge and relationships. The common assets are replicated multiple times, enabling platform owners to gain competitive advantage by enhancing production or delivery efficiency.
- A complementary set of peripheral components that exhibit high variety. The use of interchangeable peripheral components results in a diversity that creates distinctive offerings to the market.
- A stable interface that acts as a bridge between the stable core and variable peripherals, permitting innovation in both core and peripherals.
- A set of rules/standards governing how components can be integrated.

Strategically leveraging the benefits of commonality, platforms have been successfully applied across a variety of industries to deliver mass customised products, affording customers with variety of choice whilst maintaining an efficient and effective method of production.

The Hub's *Defining the Need* report quantitatively assessed a £50bn five-year pipeline, highlighting that 70% of new build social infrastructure will share commonality and consistency of geometrical characteristics. This analysis highlighted the potential for pan-government efficiencies, with sector specific assessments (such as Akerlof's *Construction Platforms in Healthcare*) reaffirming the same.

This Rulebook has been written to grasp this opportunity and accelerate the development of product platforms (outlined overleaf) in responding to the defined needs of our social infrastructure.

Fig. 1D: This range of trainers is an illustrative example of a product platform from the manufacturing sector. Low-variety common assets, produced in the same way, make up the majority of each shoe. Stable interfaces and peripheral components allow the inclusion of different soles, laces and colour finishes for a high degree of customisation and variety, delivered with consistent quality. Similar principles apply to many of the modern-day goods we use on a daily basis.



Fig. 1D: Platform shoes

WHAT IS A PRODUCT PLATFORM?

Product platforms can be defined as:

- The kit of parts, associated production processes, knowledge, people and relationships required to deliver all or part of construction projects using a platform approach:
- A product platform provides a stable core which is configured and combined with complementary components (via defined interfaces) to suit a particular project.
- A product platform also includes the processes, tools and equipment required for assembly.

Product platforms are therefore not buildings but common components, processes or knowledge, applied to deliver a range of distinct assets (that may range from specific parts to whole buildings) efficiently through economies of scale and scope.

The combination of common, repeatable assets with complementary elements, brought together with standard interfaces, enables a product platform to be extended to produce product families (a group of related products that share common features) that serve a variety of market segments.

Fig. 1E: The kitchen cabinet is an example of how a platform (a core base cabinet that has been designed and manufactured to have standard interfaces that fit with a kit of parts) can combine with complementary products to create a product family and product variants

THE PLATFORM

The platform is both the underlying elements that are common but also the rules and interfaces that govern how parts and elements can be integrated.

In this example, the platform is the standard dimensions of a kitchen cabinet - in defining a standard size it provides a common framework.

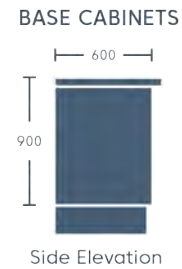

THE PRODUCT FAMILY

The product family is a group of related products that share common features, parts and systems, yet deliver variety.

In the kitchen example, the carcass size is common (the platform) with variety of functionality or purpose (i.e. drawers).

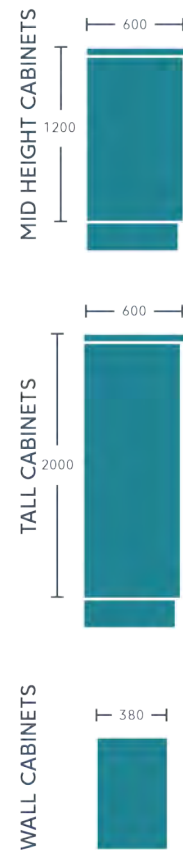

THE PRODUCT VARIANTS

Working within the framework of the platform, individual products can be variants or derivatives. For the kitchen unit example, this could include adding, removing, or substituting one or more elements - a change in door finish for example - or scaling or stretching the platform - standard base cabinets lead into mid-height or tall, wall cabinets, or double units, etc.

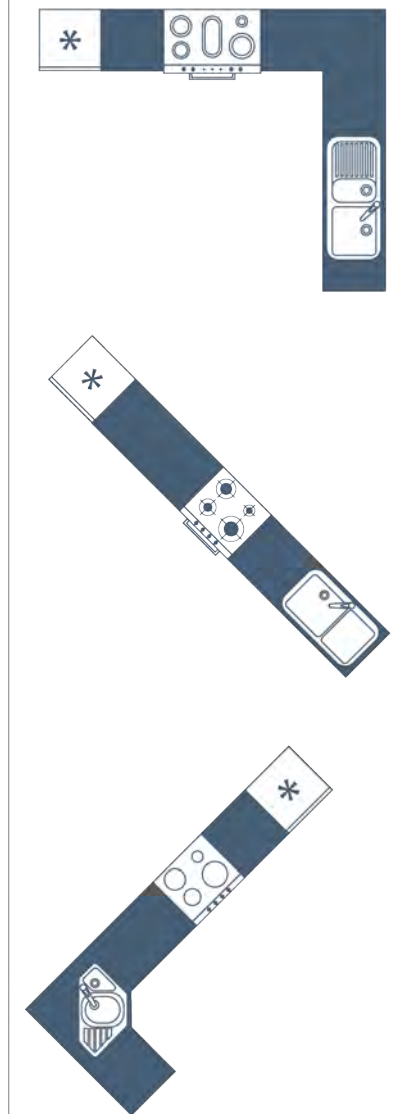
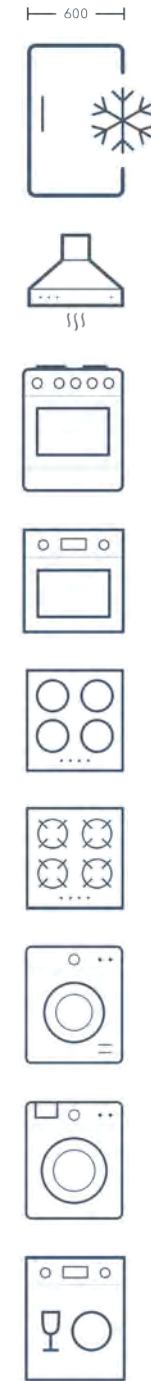
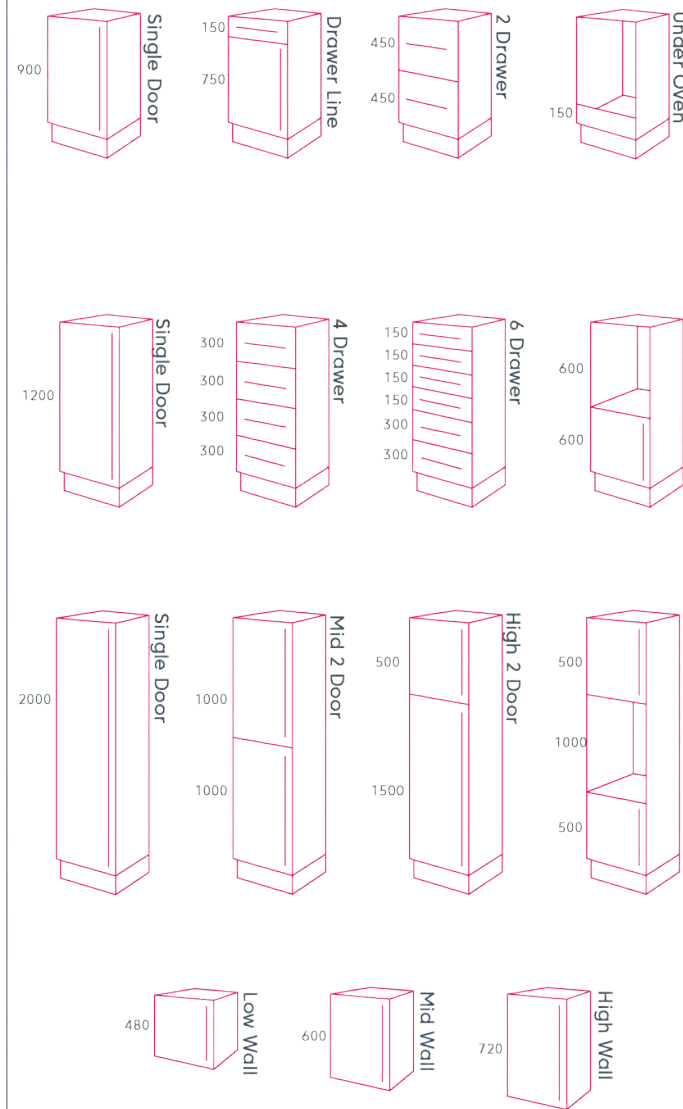

The variety of output can be applied within diverse markets across the globe, for example commercial/professional or domestic, and with a wide variety of styles - industrial, modern, farmhouse, rustic etc.

COMMON REPEATABLE ELEMENTS

COMPLEMENTARY ELEMENTS

DERIVATIVE PRODUCTS

Fig. 1E: The kitchen cabinet

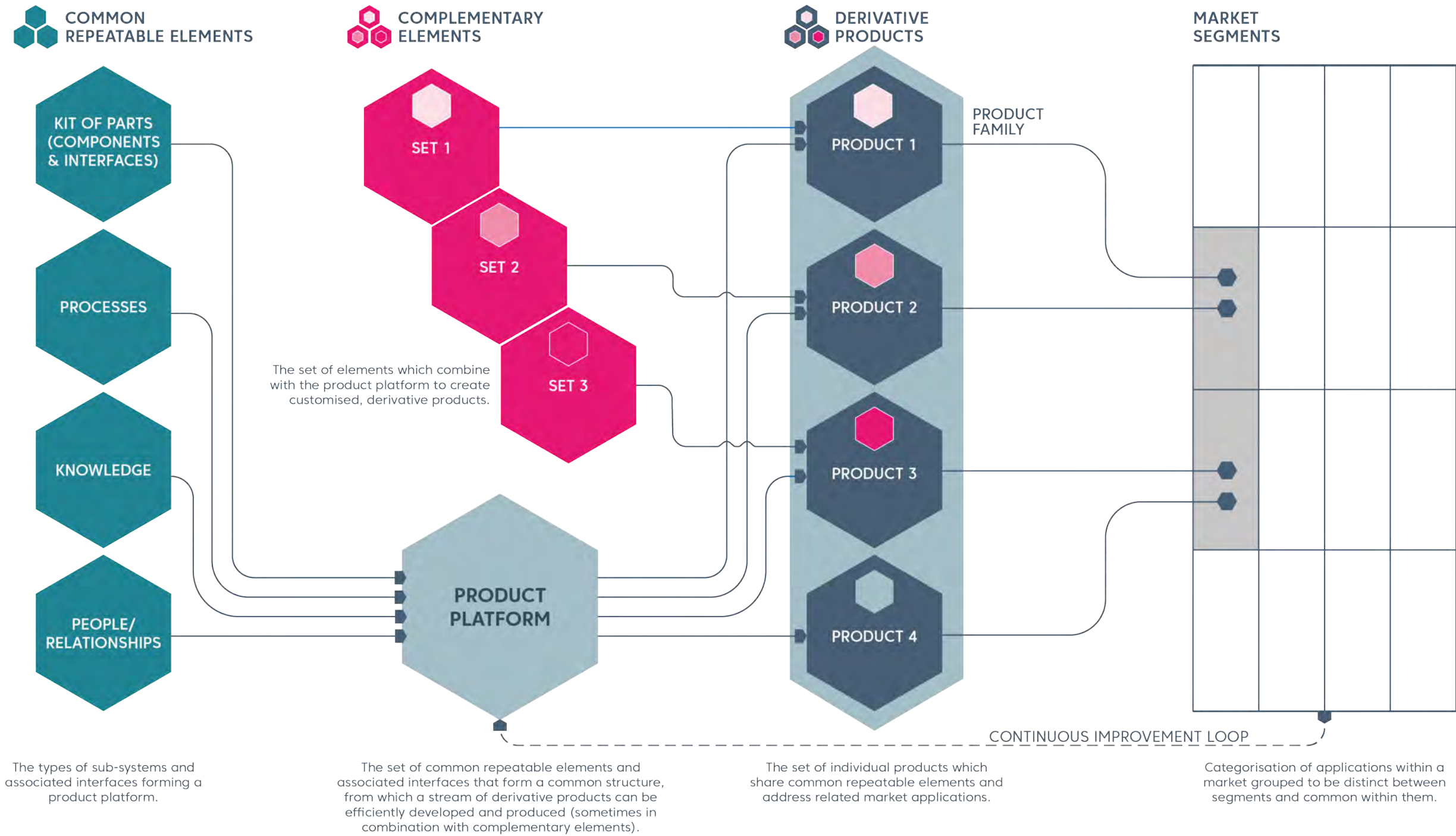

Fig. 1F: Platform Terminology

Adapted from 'The Power of Product Platforms' by Meyer and Lehnerd (1997)

PLATFORMS IN CONSTRUCTION

In 2017, Bryden Wood released a seminal book ([Delivery Platforms for Government Assets](#)) that brought into close focus the opportunity and benefits of applying a platform approach to the scale and scope of the UK Government construction portfolio. Pioneering in its vision, this text gave clear definition and assignment of title to a strategy which has, in instances, been successfully applied within the construction industry.

Open standards, developed by [ISO](#) and BSI for example, share many of the characteristics of platforms, providing a pivotal role that enables the industry to operate with degrees of commonality and standardisation, without inhibiting innovation and variety. Many clients, such as Government departments, also maintain common processes and elements across diverse delivery teams, whilst trade bodies seek to leverage consensus and commonality for the benefit of their members.

At an organisational level, companies such as British Gypsum have developed product platforms, publishing and promoting their range in an open manner that encourages adoption and interoperability with other components. The [British Gypsum White Book](#) for example, provides information and guidance for specifying partitions, wall lining and ceiling systems, guiding external parties to embed and interface BG's products. By engaging prospective clients and other members of the supply chain, with select information these product platforms can be construed as semi-open; an approach growing in prominence and usage, facilitated by the rapid evolution of digital tools such as BIM object libraries.

Albeit rarely labelled as such, many other industry players apply platform principles internally to deliver benefits to their organisations or customers. Developers within sectors such as residential, commercial, industrial and data-centres are honed towards developing buildings as products: offering customer choice within rationalised range that maintains commonality and standardisation. [Geraghty Taylor LivinHOME](#) is an open example of this, whilst [Modulous](#)' leverage a product platform as a unique value proposition that delivers benefit for their customers and their business.

As the breadth of product platforms within the construction industry is wide, so too is the strategy for their development and adoption. As outlined later within the Platform Product Development Framework, defining the rationale for adoption and desired outcomes is a critical consideration; the development of product platforms is a strategy for better outcomes, not an end in itself.

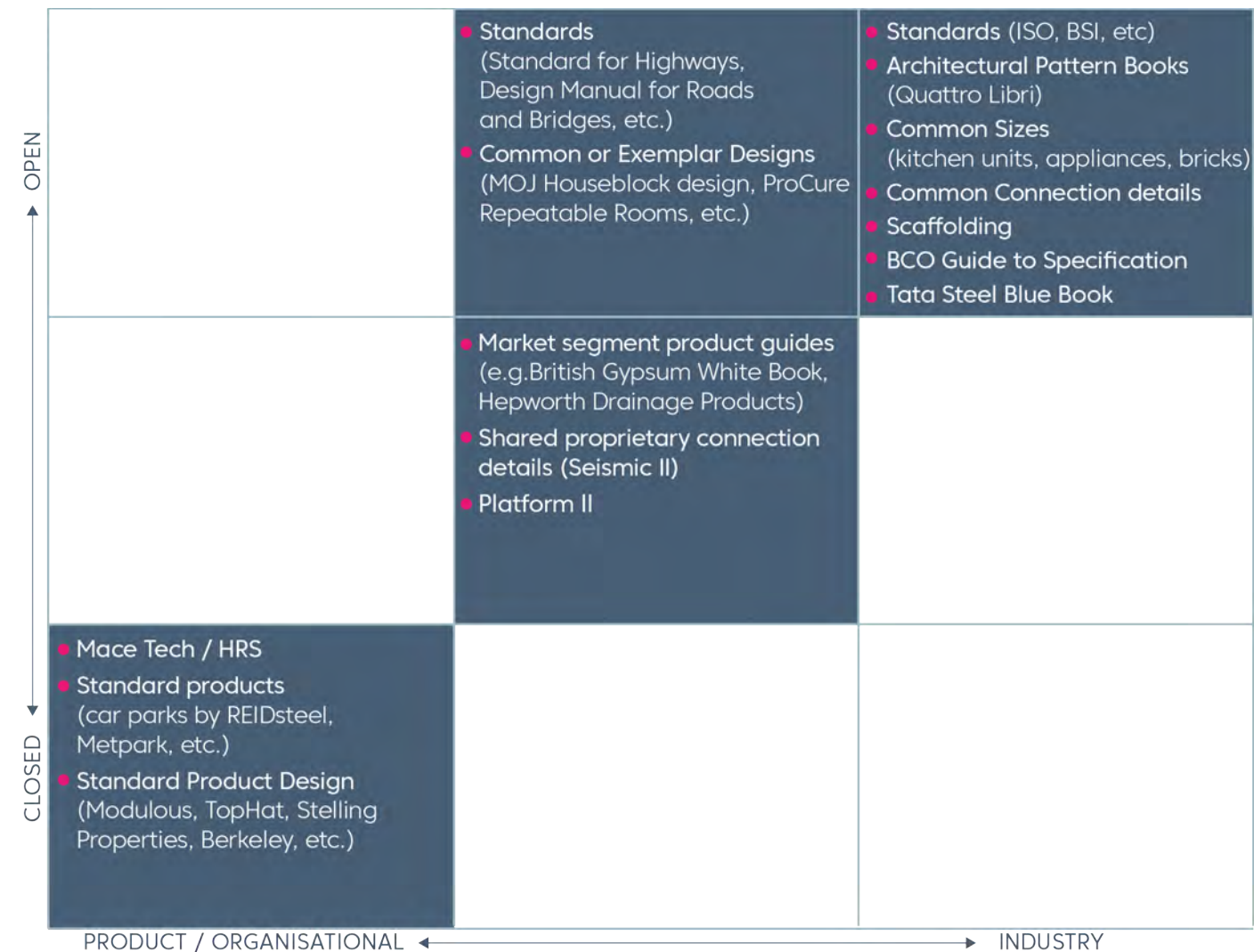
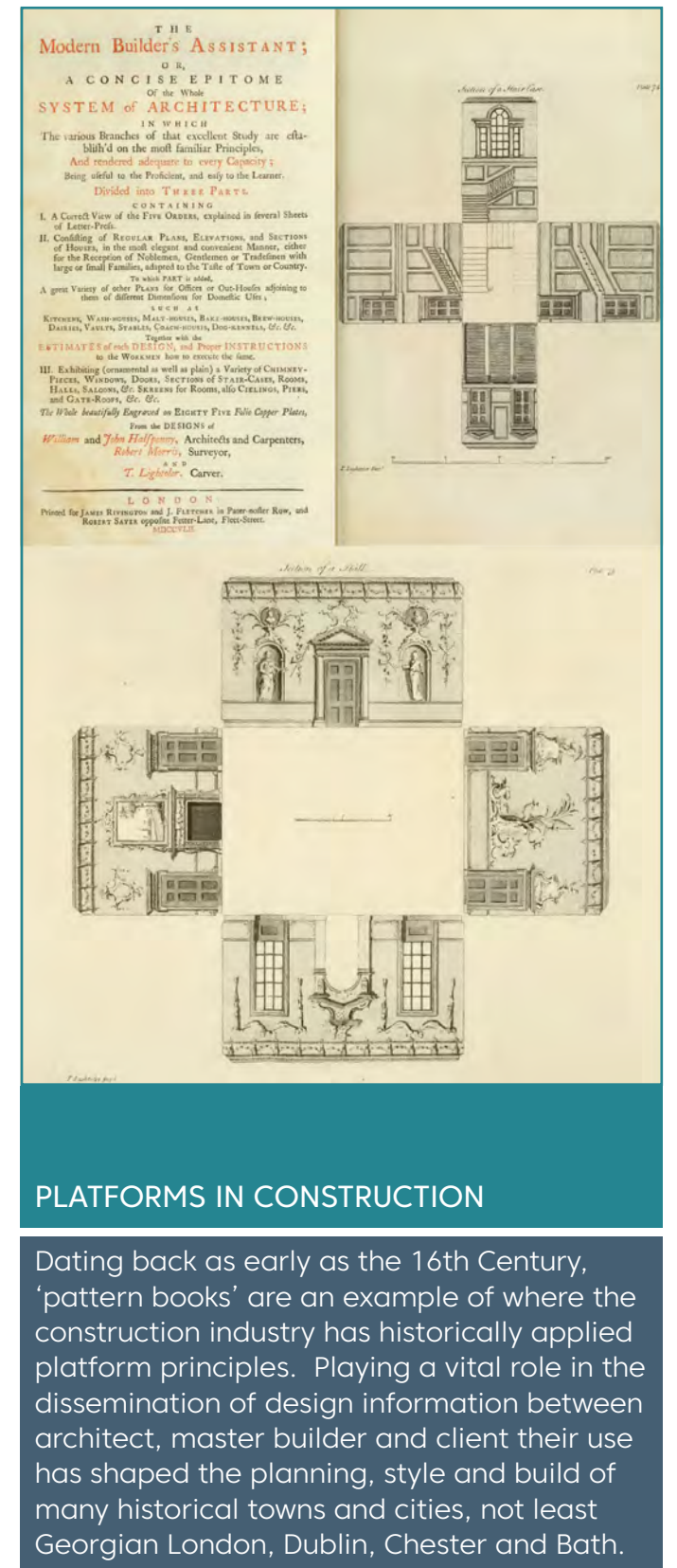

Fig. 1G: Examples of platforms within construction industry



PLATFORMS IN CONSTRUCTION

Dating back as early as the 16th Century, 'pattern books' are an example of where the construction industry has historically applied platform principles. Playing a vital role in the dissemination of design information between architect, master builder and client their use has shaped the planning, style and build of many historical towns and cities, not least Georgian London, Dublin, Chester and Bath.

BENEFITS OF PLATFORMS

The manufacturing sector has leveraged the re-use of common components, processes, knowledge and relationships for many years to deliver mass customised products at a reduced cost, faster and with lower risk. As outlined earlier, the construction industry is being encouraged to follow suit, as a way of addressing systemic issues such as low productivity, poor predictability and industry fragmentation.

By shifting the perspective from individual solutions or projects to a productised mindset, actors within the industry can begin to leverage the re-use of knowledge, designs and process to mitigate repeat work, unlock economies of scale and focus effort towards areas that add real value and continuous improvement. Furthermore, these same platform principles offer a new paradigm to the construction industry by opening the door to a manufacturing-led approach.

“By increasing scale, platforms can achieve the economies of scale and consistency of pipeline that unlocks the benefits of manufacturing.”

Bryden Wood

At an organisational and project level this affords the potential for:

1. Improved productivity, efficiency and predictability
2. Reduced cost through standardised, repeatable solutions that leverage economies of scale and scope
3. Enhanced quality control and minimised risk of rework
4. Reduction of on-site safety risk and labour
5. Reductions in waste, carbon footprint and impact upon local environment
6. Solution optimisation and continuous improvement

More broadly, government has begun to consider the wider benefits that may be realised by society through this approach; the aggregation of demand and harmonisation of requirements for product platforms is heralded to unlock opportunities for a wider, more diverse supply base and cultivate conditions that support a transition to a lower carbon, manufacturing industry.

“... the government will generate greater societal outcomes from its pipeline, by enabling a disaggregated manufacturing industry that creates stable and inclusive employment where jobs are most needed.”

IPA's Transforming Infrastructure Performance Roadmap to 2030

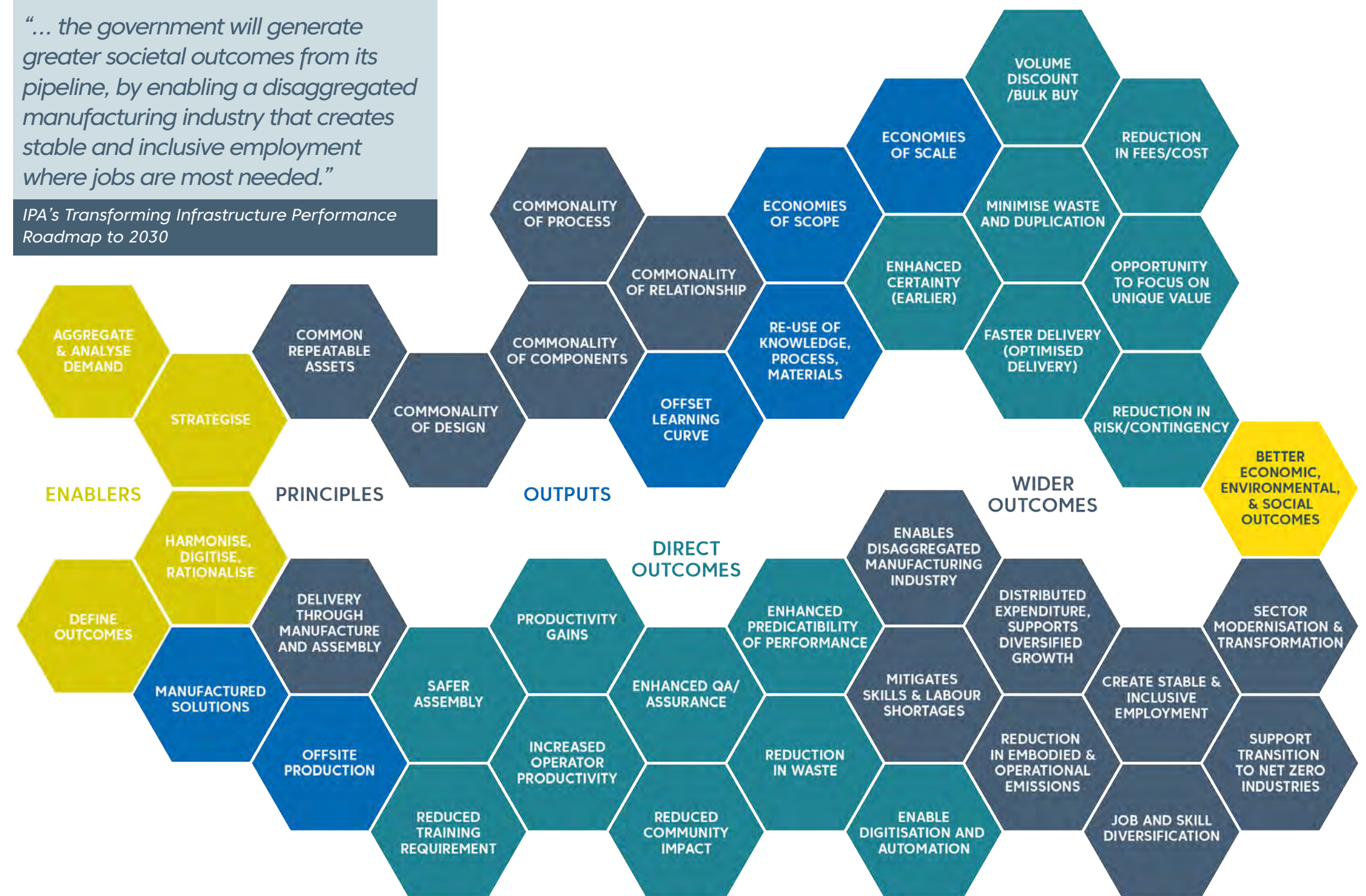

Fig. 1H: Benefits of platforms

CHALLENGES

“Commonality is a strategy for developing better products. Commonality is not an objective in itself...”

NASA

Whilst espousing the benefits of product platforms, they are, like all best practices, only ‘best’ in certain contexts and to achieve certain objectives. The decision to develop a product platform is a strategic choice, requiring clarity of vision and recognition that not everything can or should be delivered through product platforms.

As outlined later within the Product Platform Development Framework, definition of the intended benefits mapped against the quantity, nature and variability of product demand, is critical to establishing a business case for investment, resource and co-ordination required.

The Hub’s *Defining the Need* report demonstrated a methodology for aggregating and rationalising demand to inform the business case at a pan-government level; it also acknowledged the potential paradoxes of platforms, where the intended result can contradict the expectation.

The complexities and challenges associated with defining and implementing product platforms, particularly at the scale expressed by government, are not to be under-estimated. Construction’s opportunity to draw advantage from the manufacturing industry includes benefiting from their learning curves; where possible such lessons learnt have been factored into the Rules, Principles and Development Framework included later within this book.

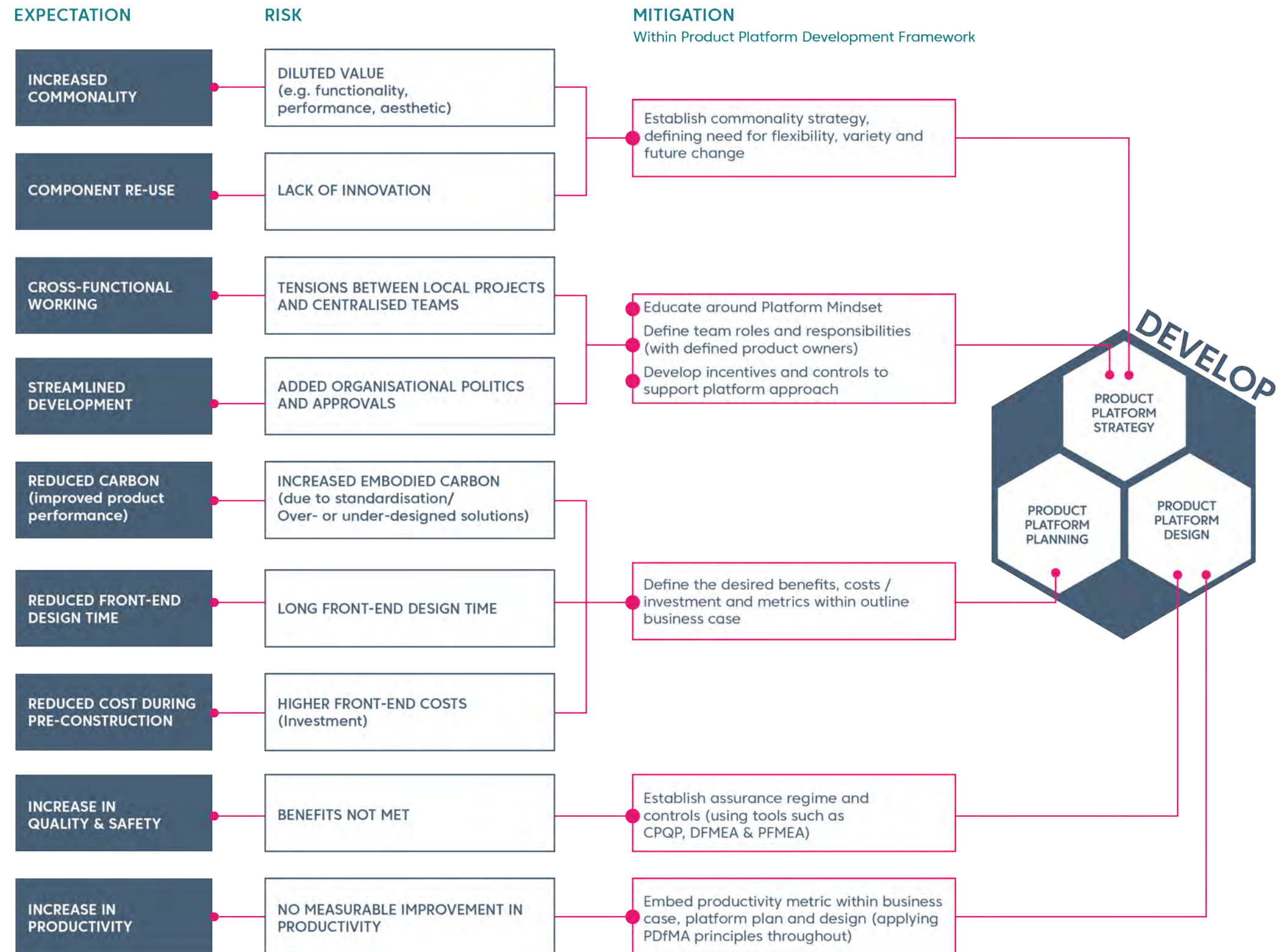

Fig. 11: Expectations of product platforms do not always align with reality and thus the Product Platform Development Framework has been established to mitigate this risk. Adapted from MIT - Designing Product Families: From Strategy to Innovation (2020)

Fig. 11: Expectations of product platforms

INTELLECTUAL PROPERTY AND LIABILITY

Product platforms deliver benefits when common assets are deployed at scale and with defined interfaces with complementary products. Whilst this offers the promise of efficiencies and economies, it can provoke concerns around intellectual property, risk ownership and liabilities. The origins of such concerns often depends upon the nature of the organisation, the context, and the type of platform being developed.

Adopting a platform approach, as a new way of working, may require adaptations in the contractual agreements between organisations. Whilst Fig. 1J suggests that this may not be as fundamental a shift as many think, it is important nonetheless that the ecosystem of any product platform has clearly defined relationships, aligned interests, and appropriately allocated risks.

Consistent with the Construction Playbook, the delivery model should be carefully considered as part of a platform strategy; without clarity on fundamental principles such as ownership and risk, any plans to deliver at scale will falter at the first hurdle.

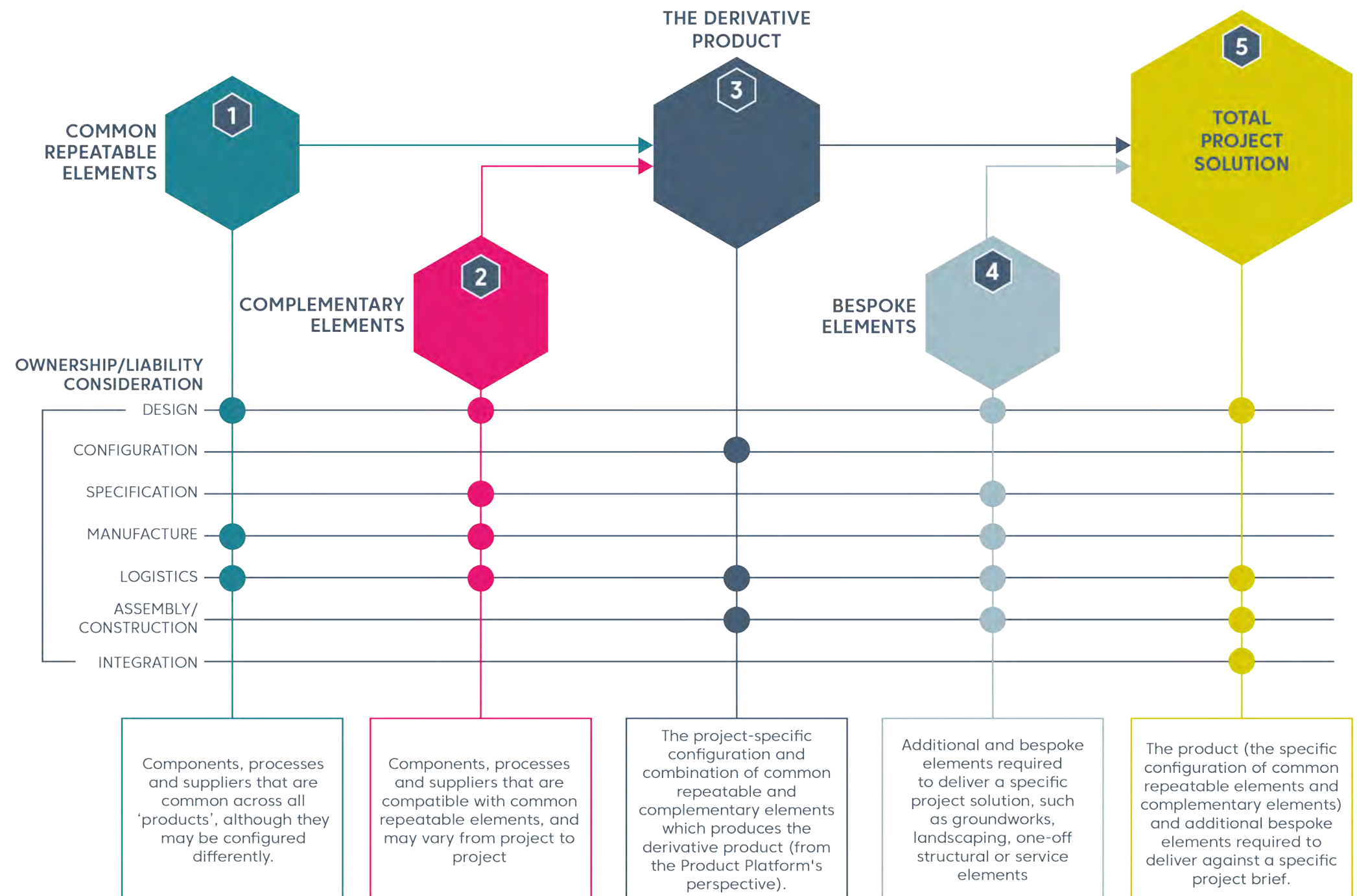

Fig. 1J: Intellectual property, ownership and liability considerations

THE TRANSFORMATION

Product platforms require a sensitive balance between commonality and the need for distinction and flexibility. Technically, a successful platform will have sufficient commonality across a range of product variants to create efficiencies, yet enough variants and unique elements (parts, processes, knowledge or relationships), to satisfy the varying needs of multiple customers.

Fig. 1K shows how common repeatable, complementary and bespoke elements are defined and how they fit together.

- **BESPOKE ELEMENTS** are, as the name implies, bespoke or unique to only one variant. Bespoke parts differentiate products or projects from one another.
- **COMPLEMENTARY ELEMENTS** are shared by two or more products that differ in one or more aspects, such as feature, size, or colour.
- **COMMON REPEATABLE ELEMENTS** are shared by all of the product variants and are identical.

The ability to achieve this optimum state is often complicated by the reality of varying and competing demands and considerations, both internally and externally, leaving a state of design uncertainty.

The Product Platform Development Framework included within this Rulebook is intended to act as source of reference and guide in developing a strategy and plan that addresses this uncertainty.

Whilst this Rulebook predominantly focuses on providing technical guidance, readers should recognise that the transformation required to successfully embed product platforms will require adaptations in process, mindset and interactions both within and outside organisations.

The capacity to realise the potential of commonality, compatibility and standardisation will require for many a shift in organisation construct, necessitating multi-party co-ordination and greater collaboration (see Fig. 1L). Some of these shifts are set out in Fig. 1M overleaf.

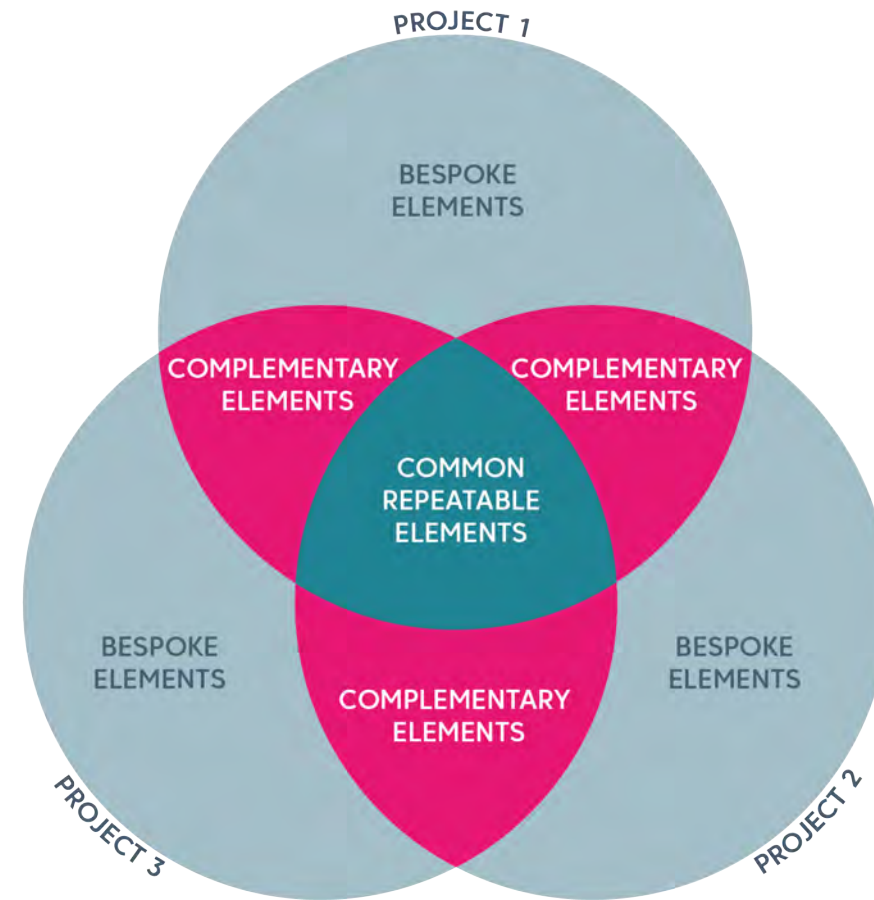

Fig. 1K: Common repeatable, complementary, and bespoke elements all play a role in a successful platform. The New Hospitals Programme have applied these principles to measure and evaluate the commonality and repeatability of rooms (spatially) as well as building components (parts).

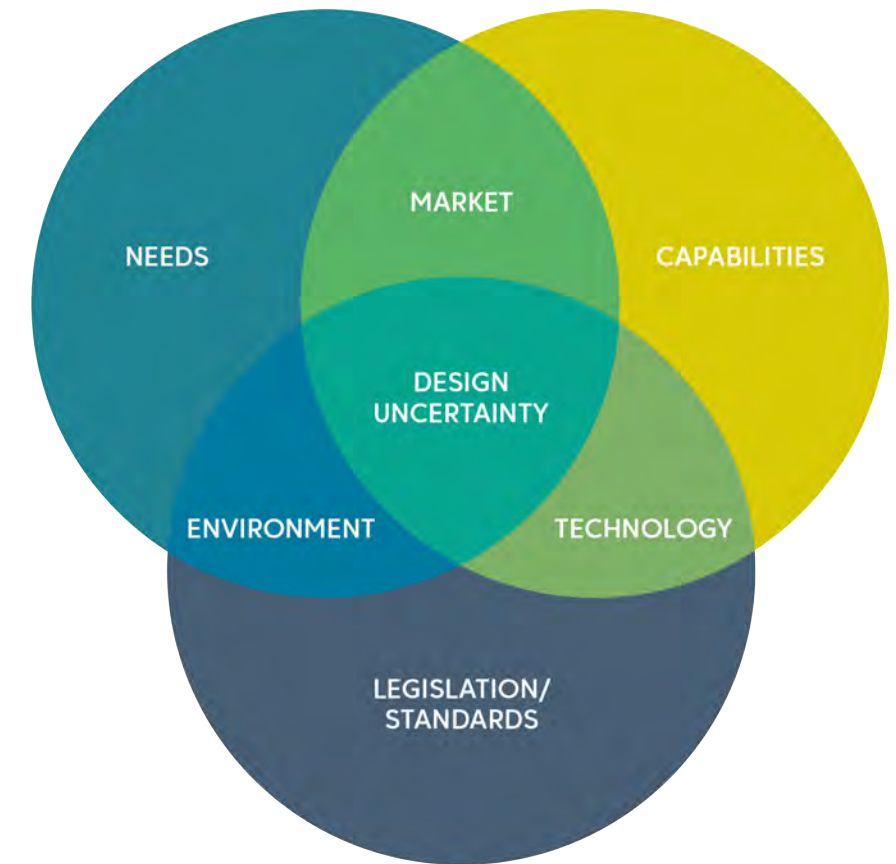

Fig. 1L: Adapted from Nadadur et al, 2012 'Strategic Product design for Multiple Global Markets'

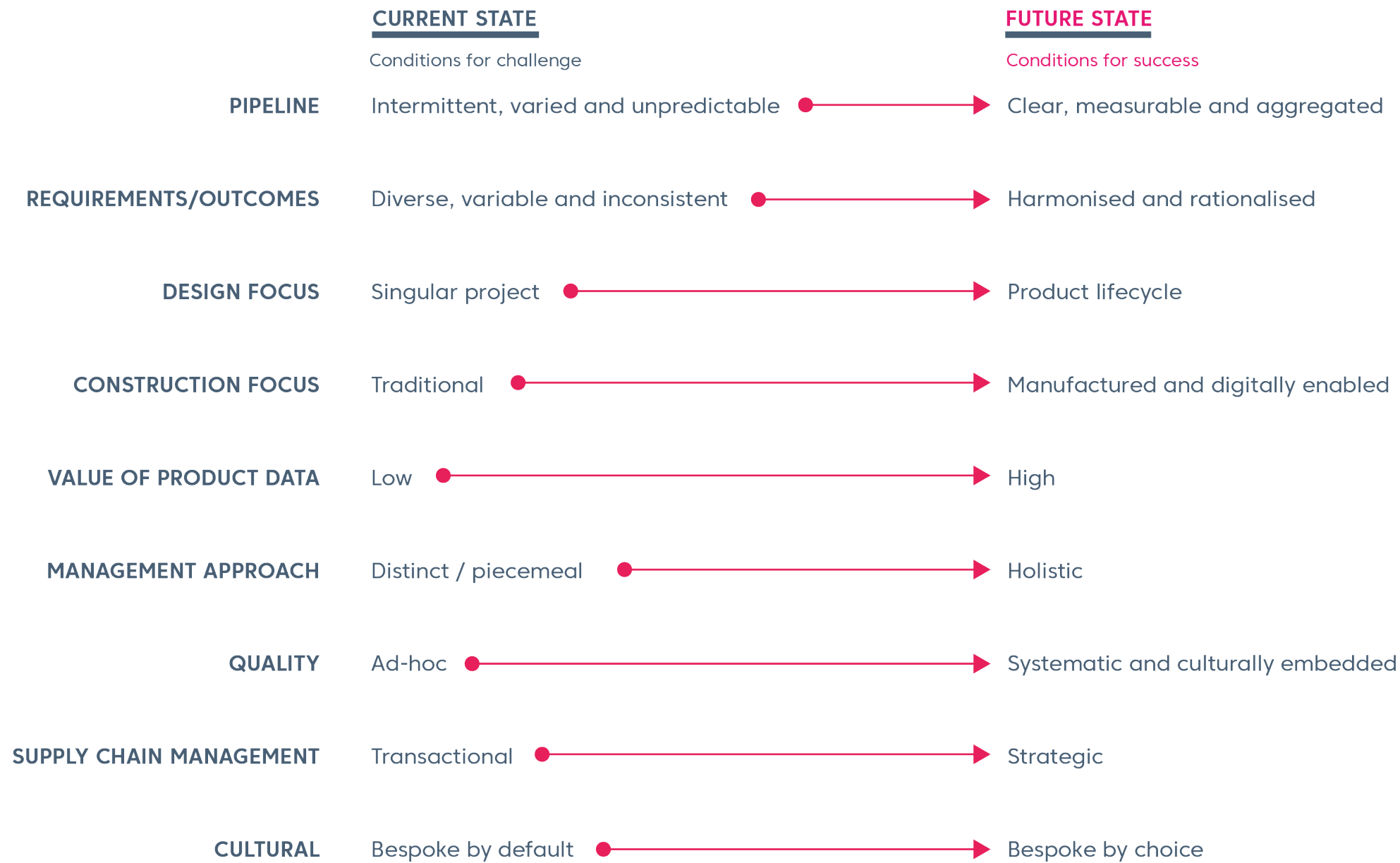
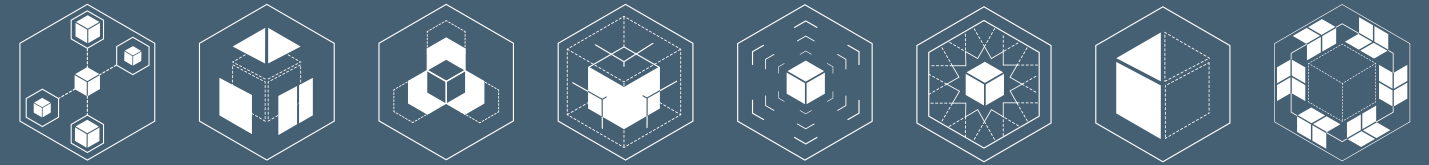

Fig. 1M: Conditions for success and challenge

2. THE RULES



2.1. Scope

The Rulebook establishes the Rules and Principles for product platforms in construction and provides supporting explanations. The Rulebook only covers activities that are specific to the development of a product platform: activities that would take place irrespective of whether or not a product platform is being used, and are unchanged by its development, are outside of its scope.

2.2. Distinction between Rules and Principles

Depending on the character of individual clauses, distinction is made in the Rulebook between Rules and Principles.

The Rules 1-5 comprise general statements and definitions for which there is no alternative; as well as requirements for which no alternative is permitted unless specifically stated.

The Principles 6-8 are requirements which should be applied in conjunction with the Rules.

Compliance with the Rules determines whether something can be considered a product platform or not. Performance against the Principles determines how advanced a product platform is.



1. DEPLOYABLE

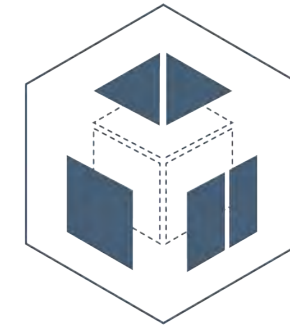

2. CONFIGURABLE



3. COMMON REPEATABLE ELEMENTS

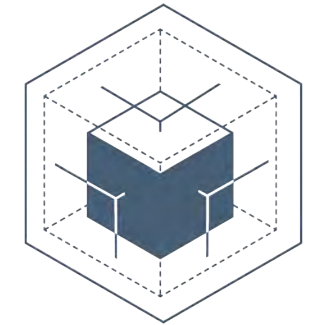

4. INTERFACES

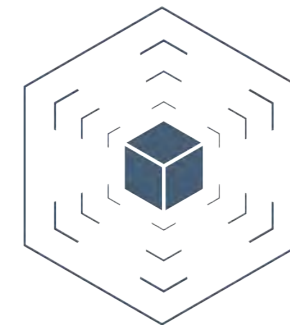

5. OPEN

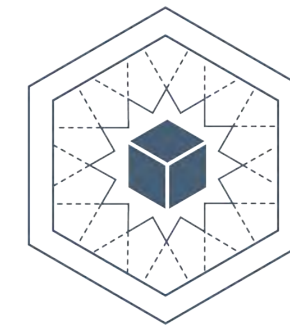

6. QUALITY

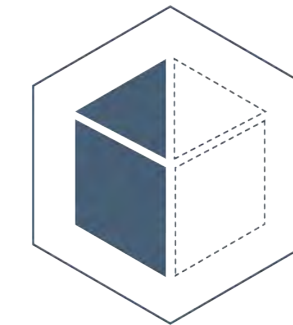



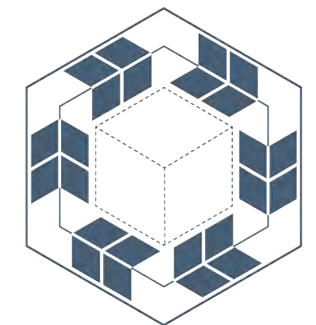

7. STRUCTURED INFORMATION



8. CIRCULAR

2.3. Rules and Principles

	RULE (IS IT A PLATFORM?)	RULE INTENT	WHAT GOOD LOOKS LIKE
1	 <p>1. DEPLOYABLE Product platforms shall be deployable across multiple, non-identical assets</p>	That it is possible to physically deliver non-identical buildings or parts of buildings using the product platform - to distinguish from a one-off or a cookie cutter repetition.	Product platforms should be flexible without being inefficient. Buildings – and the industry which delivers them – are sufficiently diverse that one ‘globally optimal’ discoverable solution is doubtful. Product platform providers should work together to identify opportunities for standardisation and sharing across product platforms. Such collective convergence will drive even greater benefits for the built environment.
2	 <p>2. CONFIGURABLE Product platforms shall be configurable to suit individual project requirements</p>	That it is possible to comply with variations in requirements across different projects while still using the common repeatable elements of the platform.	Flexibility is essential to accommodate the need for good design, varying needs placed on individual buildings, and place-based context. But we still need to ensure efficiency (in material, labour and capital) in the solutions we create.
3	 <p>3. COMMON REPEATABLE ELEMENTS Product platforms shall comprise common repeatable elements including:</p> <ul style="list-style-type: none"> • <i>A kit-of-parts</i> [i.e. physical components] • production processes [i.e. the methods used to produce the kit-of-parts, and associated information systems] • <i>Knowledge</i> [i.e. the market insight, customer insight, operating procedures, intellectual property, methods and skills needed to develop, produce and enhance the kit-of-parts and production processes] • <i>People and relationships</i> [i.e. the individuals (and associated roles, authorities, responsibilities) needed – as well as the environment and incentives for those people, which may extend to contractual relationships between organisations] 	That there is holistic consideration of improving productivity and risk across all aspects of the delivery process, whilst accepting that different product platforms will share elements to differing degrees.	Product platforms should facilitate a disaggregated supply chain, with common repeatable elements able to be supplied by multiple, independent manufacturers. Product platforms should ensure their use of common repeatable elements does not inhibit their ability to satisfy specific security considerations for their intended applications.
4	 <p>4. INTERFACES Product platforms shall have defined interfaces which can be made available to the designers and suppliers of peripheral or complementary products.</p>	To enable the product platform to be reliably integrated with other parts of a building without being wholly dependent on the platform provider.	Product platforms should work together to identify standard interfaces which can be used across the industry and promote interchangeability and fungibility of elements (products, processes, skills and capabilities, organisations).
5	 <p>5. OPEN For a product platform to be deemed an open product platform, it shall enable any party to make, use and buy the common, repeatable elements, for legitimate purposes.</p>	To enable a consistent understanding of what it means to be an open platform.	Open product platforms should provide an open foundation on which others can develop complementary products, services and technologies; they should have a stable architecture with open interfaces. Open product platforms should reduce the barriers to adoption through accessible information and tools, the use of commercially available products and open, performance-based production requirements, skills and know-how required to produce and assemble Open Product Platforms.



	PRINCIPLE	PRINCIPLE INTENT	WHAT GOOD LOOKS LIKE
	<p>6. QUALITY Product platforms shall have a defined quality standard</p>	<p>To define a minimum level of quality to be achieved, and have documents and procedures in place (requirements, specifications, guidelines, or characteristics) that can be used consistently to ensure that materials, products, processes, and services (as appropriate) are fit for their intended purpose.</p>	<p>Product platforms should facilitate an improved quality standard – to develop and provide product platforms that will correspond to the requirements and to the assumptions made in project designs, appropriate quality management measures should be in place. These measures should include as a minimum:</p> <ul style="list-style-type: none"> • Definition of the reliability requirements • Organisational measures • Controls at the stages of design, execution, use, maintenance and, where appropriate, end of life. • The design working life of a product platform should be specified, with time-dependent performance determined accordingly such that deterioration over the design working life does not impair the performance of the product below that intended, having due regard to its environment and anticipated level of maintenance. <p>Construction Product Quality Planning (CPQP) sets out a quality framework process that should be followed during the creation of new construction products.</p> <p>Quality is not solely defined by product manufacturing but is also defined by wider strategic objectives, as reflected in the Value Toolkit. These strategic objectives are defined by stakeholders - anyone who has an interest in the success of what your organisation does. (What is quality? CQI IRCA)</p>
	<p>7. STRUCTURED INFORMATION Product platforms shall have a structured approach to information for:</p> <ul style="list-style-type: none"> • Product information; • Deployment information; • Organisational information; including capability and credibility. 	<p>To enable those in the client domain to make an informed choice about the use of the platform and how it will affect outcomes; and to enable those in the product domain to feed in their information seamlessly.</p> <p>To enable those in the project domain to correctly evaluate, configure and deploy platforms.</p> <p>To apply appropriate and proportionate security controls to sensitive product, deployment, and/or organisational information.</p>	<p>Product platforms should promote interoperability on a technical, legal, semantic and organisational level.</p> <p>Product platforms should facilitate convergence to a consistent approach to structured information, enabling interoperability across the supply chain. This includes (but is not limited to) the following aspects:</p> <ul style="list-style-type: none"> • Product information: <ul style="list-style-type: none"> • Value • Interface and compatibility • Limits of applicability • Past performance and credibility (accreditation, compliance, quality assurance) • Deployment information: <ul style="list-style-type: none"> • Lead times and capacity • Offsite activities and requirements • Logistics requirements • Onsite activities and requirements • Compliance and quality assurance • Organisational information; including capability and credibility • Sensitive information • Structured quality information in line with CPQP and the Golden Thread Audit Trail • Follows the Digital Compliance Ecosystem
	<p>8. CIRCULAR A product platform shall enable a degree of circularity for components and sub-assemblies beyond their first intended deployment. The degree of circularity shall be evidenced.</p>	<p>To ensure that products have been designed for disassembly, repair, or reuse at the end of use and that the manufacturer has provided detailed information on maintenance, reuse, disassembly and recovery options.</p>	<p>Product platforms and complementary elements should be designed to be easy to separate, without destruction of components, and all necessary instructions for maintenance in-use and cycling at end of use are indicated or attached to the product or otherwise available to subsequent owners of the asset. Element specifications should be based on a 'Design for Deconstruction (DfD)' checklist and scoring criteria, covering reuse potential, connections, accessibility and deconstruction processes. Lifecycle Analysis (LCA) should be utilised, including modelling and analysis of renewable energy technologies. Evidence can be provided through Public Type III EPD including lifecycle impacts; Cradle to Cradle certification in the Materials Reutilization or Product Circularity categories; proof of leasing products as a service; proof of purchase of refurbished or remanufactured products.</p>

Fig. 2A: The rules and principles

3. GUIDANCE

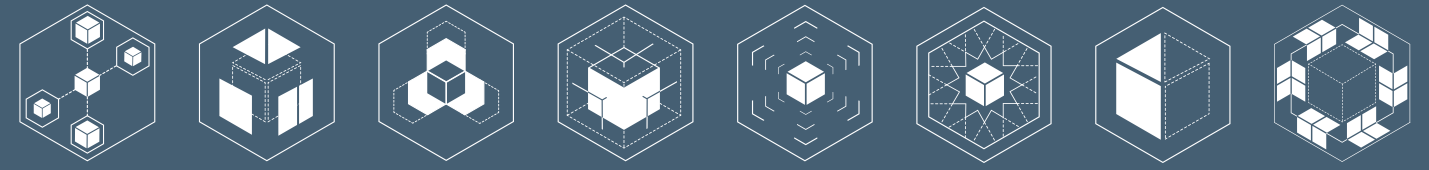

With an understanding of what product platforms are in the construction context, we will now explore the conditions required to enable their use, provide guidance for those looking to develop them and discuss the maturity and step-changes required by industry to facilitate this.

It is important to note that commonality and standardisation, while valuable, is not in itself sufficient to develop a successful product platform. Standardisation of all components and processes yields a rigid and inflexible platform, making renewal and customisation difficult. One of the central challenges of platform development is determining which components and processes ought to be standardised, and where flexibility and customisation need to be retained.

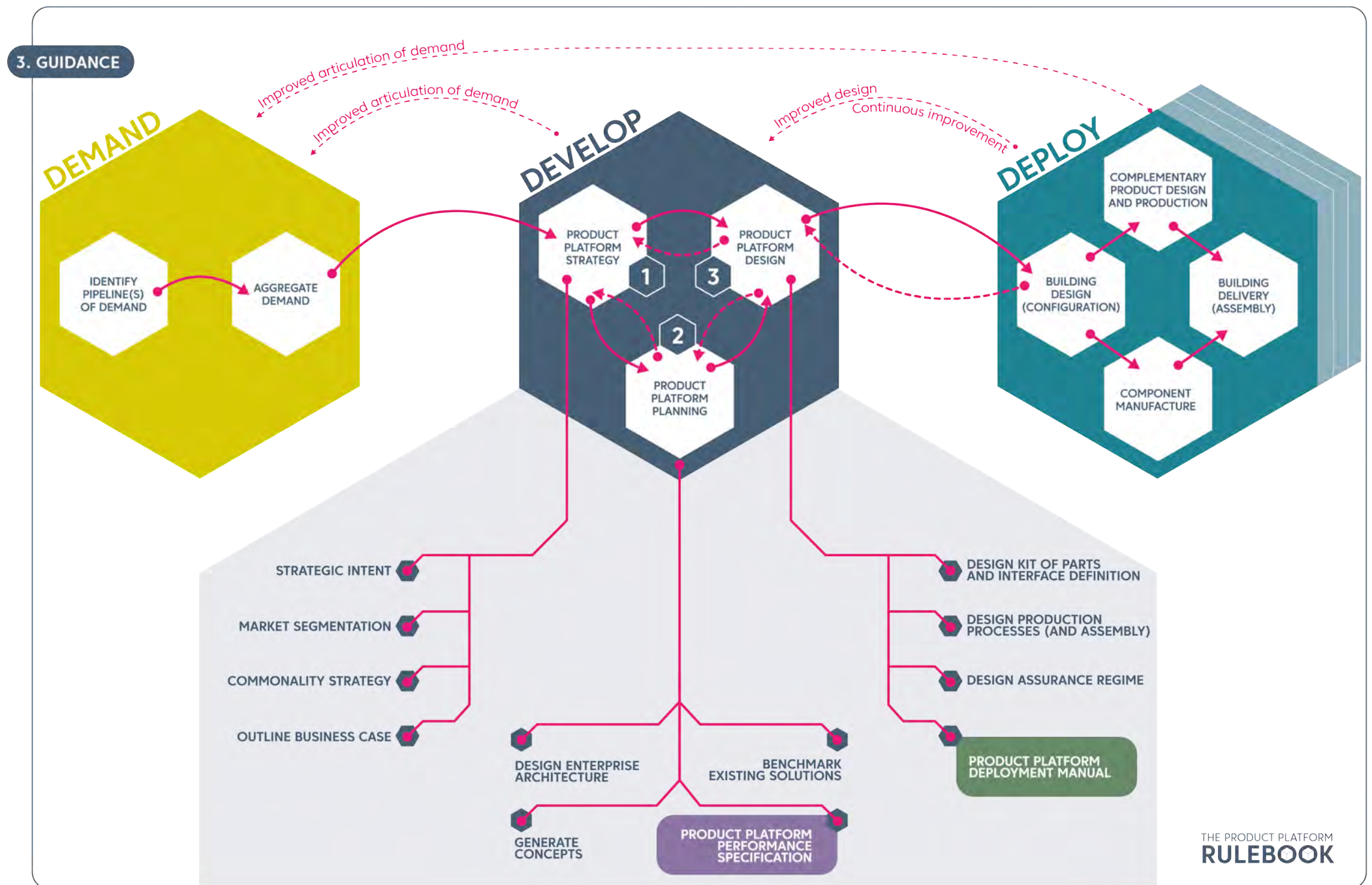

Fig. 3A: The three steps of the Develop stage of the Product Platform Development Framework
1. Product Platform Strategy 2. Product Platform Planning and 3. Product Platform Design

3.1. How the industry must change to enable product platforms

To identify the key enablers for adoption of product platforms in construction, it is important that we understand the context in which they will be applied. Broadly speaking, the construction sector has three primary 'domains':

1. The client domain
2. The project domain
3. The product domain

Each domain plays a vital role in the construction of the built environment, but the way the domains interact often creates inefficiencies, which could in some cases be addressed by the emergence of product platforms.

PLEASE NOTE: The following sections are not intended to be an exhaustive account of the features of the industry, but an account of those features which impact upon its ability to accommodate product platforms.

CLIENT DOMAIN

The client domain represents those responsible for the delivery, operation and management of the built environment, ranging from large 'portfolio' clients such as government departments, down to those concerned with individual assets. Similarly, the role of client varies, from those simply delivering assets (e.g. developers) to those owning and operating long-term portfolios.

Demand for construction services (new construction, refurbishment, demolition etc.) originates in the client domain. Such demand is usually articulated through discrete projects or programmes, and clients interface with temporary groups of organisations in the project domain to deliver them. Accordingly, the requirements (technical, value etc.) associated with this demand, and the way services are procured, often vary from project to project.

In the client domain, 'construction works' are often considered in isolation from operational activities. This means the link between design and construction and operational performance and outcomes is often lacking and the opportunity for continuous improvement is limited.



PROJECT DOMAIN

The project domain represents those organisations involved in the design, delivery and management of construction works. As stated above, asset management services are generally not considered to be part of this domain, although there has been an increase in business models and contracts attempting to bridge this gap (e.g. 'design, build, operate' contracts). It contains thousands of organisations, from large multinational contractors and consultants through to small specialist subcontractors, and is dominated in volume by SMEs with high levels of self-employment and subcontracting.

The project domain is predicated on groups of these organisations coming together, temporarily, to deliver construction works against the clients' specific requirements and procurement approach. As such, organisations operating in the project domain often have poor sight of long-term demand pipelines, and their project-based business model and uncertainties over procurement means they often lack the confidence to invest in training and innovation outside of specific projects and programmes.

The temporary and variable nature of projects (in terms of size, time, site and client requirements) makes for a fragmented and specialised delivery process, which is challenging to make more efficient through continuous improvement. Similarly, a lack of long-term, structured feedback from operational activities also prevents continuous improvement in asset design.

Organisations in the project domain interface with the product domain to select products and services suitable for deployment on a given project and in response to the specific requirements associated with it.

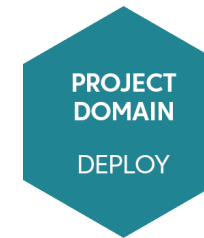

PRODUCT DOMAIN

The product domain represents those responsible for the extraction, processing and manufacture of construction materials and products. Products range from commoditised materials supplied to a wide marketplace, to bespoke solutions with a single customer. The organisations in the product domain range from large multinational materials groups to specialist SME component manufacturers, who supply their products into projects and programmes within the project domain in line with specific requirements.

There is little direct dialogue between the client domain and the product domain, with the project domain acting as the gateway (and translator) between client requirements and technical solutions. As such, conversations relating to standardisation and rationalisation of client requirements are often restricted to those achievable within the realms of a project or programme – missing the opportunity to look for scale advantages across clients, projects and programmes.

Continuous improvement in the performance of construction products - and/or their contribution to the performance of the delivery process - is challenging, due to the bespoke way that products are brought together in the project environment, the level of customisation currently required and a lack of feedback from operational activities in the client domain (or subsequent construction works).



SUMMARY OF THE CURRENT STATE

In summary of the above, demand for construction works originates in the client domain as discrete projects or programmes delivered by temporary groups of organisations in the project domain. These projects and programmes interface with the manufacturers and suppliers in the product domain to source and bring together construction materials and products which meet the specific requirements of a project or programme.

The temporary nature of projects, and the separation between construction works and asset operations, prevents continuous improvement in either process or product and a lack of direct dialogue between the client and product domains prevents economies of scale being realised.

FUTURE STATE ENABLERS

The most fundamental collective enabler for change – in line with the ambitions of Government ([TIP2030](#)) – is for the construction sector (represented by the project domain) to be recognised as a component of the wider built environment. Construction projects should not be seen as discrete activities, but as repetitive interventions into an existing system. With this mindset, we can recognise the value of creating stronger links between assets, projects and products.

Secondly, we must recognise that although the demand for construction works across the built environment is vast and continuous, the way in which it is passed into the project domain does not take advantage of this scale. The way in which pipelines and associated requirements are articulated need to be harmonised. This will allow those in the project and product domains to more easily aggregate demand for products and services but will also provide the foundation for increased rationalisation of requirements.

Organisations across the client domain will need to work together to agree common standards against which pipeline data and client requirements are communicated.

With this in place, clients can then work closely with organisations in the project and product domains – outside of the project environment – to identify opportunities to rationalise their requirements. Such rationalisation exercises require a clear understanding of where differentiation is necessary and valuable (e.g. security requirements) and where it is adding unnecessary cost and complexity to product and process. Critically, this conversation should be solution agnostic, leaving the market to respond and driving continuous improvement through competition.

With the three domains operating in this manner, projects will no longer be seen as the starting point for design and construction activities but the final step in the configuration and deployment of pre-engineered solutions (including but not limited to product platforms). The focus of the project domain will therefore shift towards product customisation and process optimisation, including evaluation and configuration of existing solutions, management of interfaces and assembly processes, and execution of any complementary design and construction works*.

**It is unlikely that project requirements can be entirely satisfied through the deployment of pre-engineered solutions and product platforms – however, it is expected that their use will have knock-on benefits for bespoke design elements through the provision of clear system boundaries and interfaces.*

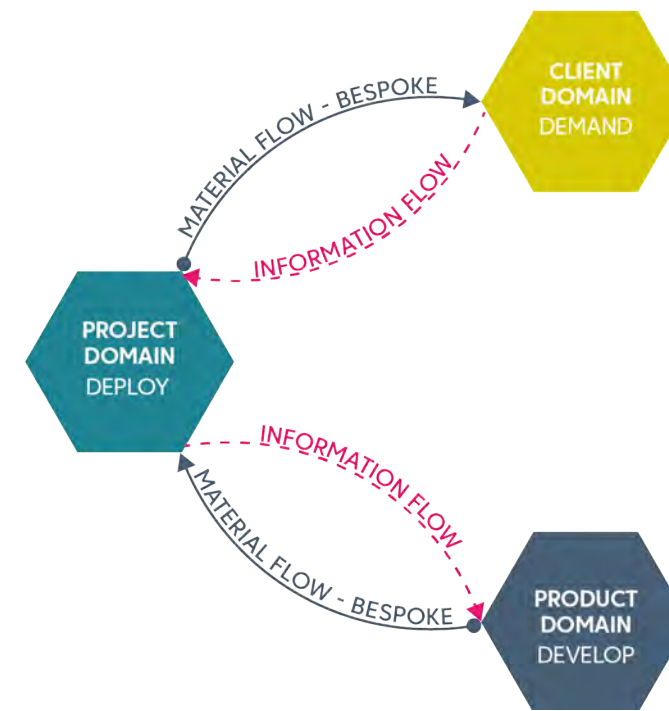

Fig. 3B: Current State
The lack of connection between the Client and Product domains results in a bespoke material flow

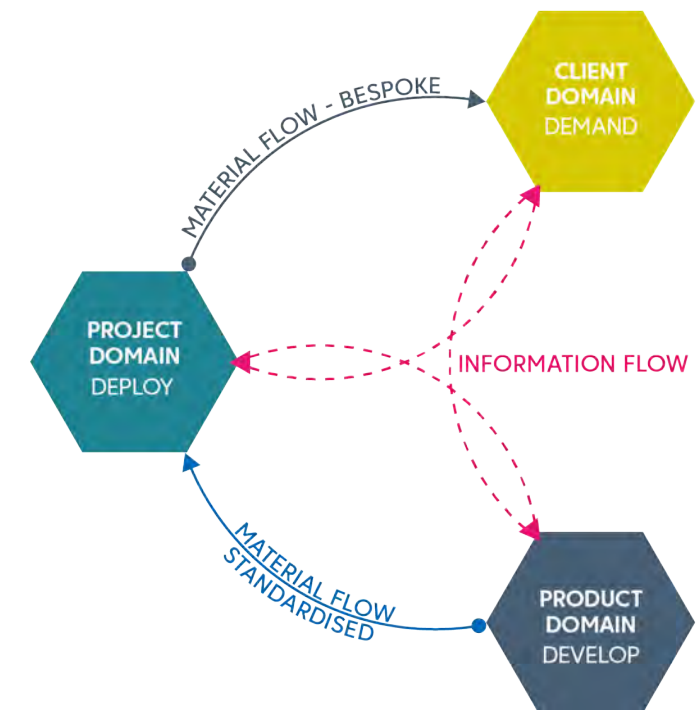

Fig. 3C: Future State
Material and information flows within the desired future state, with platforms being widely utilised.

SUMMARY OF THE FUTURE STATE

In summary of the above, instead of information from the client domain flowing exclusively to the project domain, it now flows to both the project and product domains. The product domain uses this information to supply standardised, rather than bespoke, products and materials to the project domain. The project domain configures these standardised products and adds limited bespoke activity and material to complete the required projects.

3.2. Product Platform Development Framework

The previous chapter outlines the three primary construction domains and the change in the relationship between them that is required to enable the introduction of product platforms.

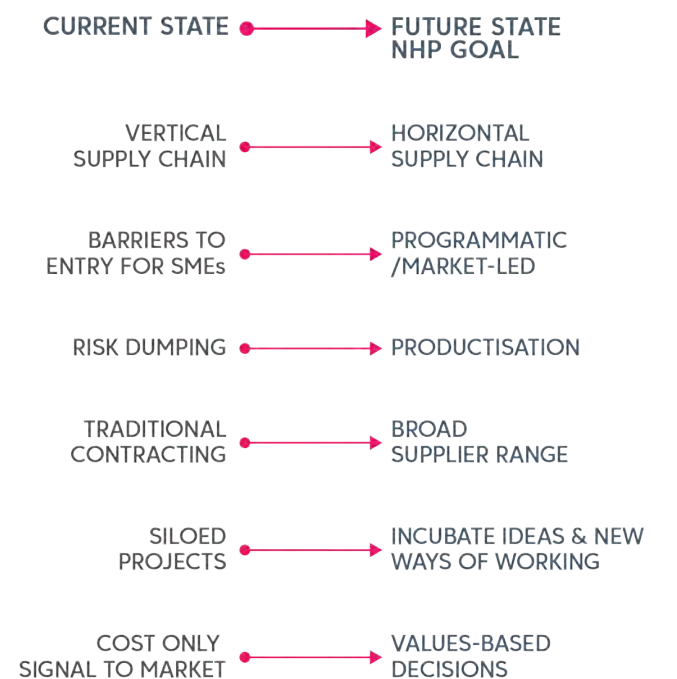

Fig. 3D: Aspirations of the New Hospital Programme

Building on this, the Product Platform Development Framework (Fig. 3E) provides a summary of the core activities that need to be undertaken in each domain for the successful development and deployment of product platforms.

It should be noted that there is a multiplying effect through the framework. That is to say that the 'demand' activities undertaken in the client domain should lead to the 'development' of multiple product platforms in the product domain, each of which will be 'deployed' many times in the project domain.

The following sections describe each of these core areas of activity and the objectives within them.

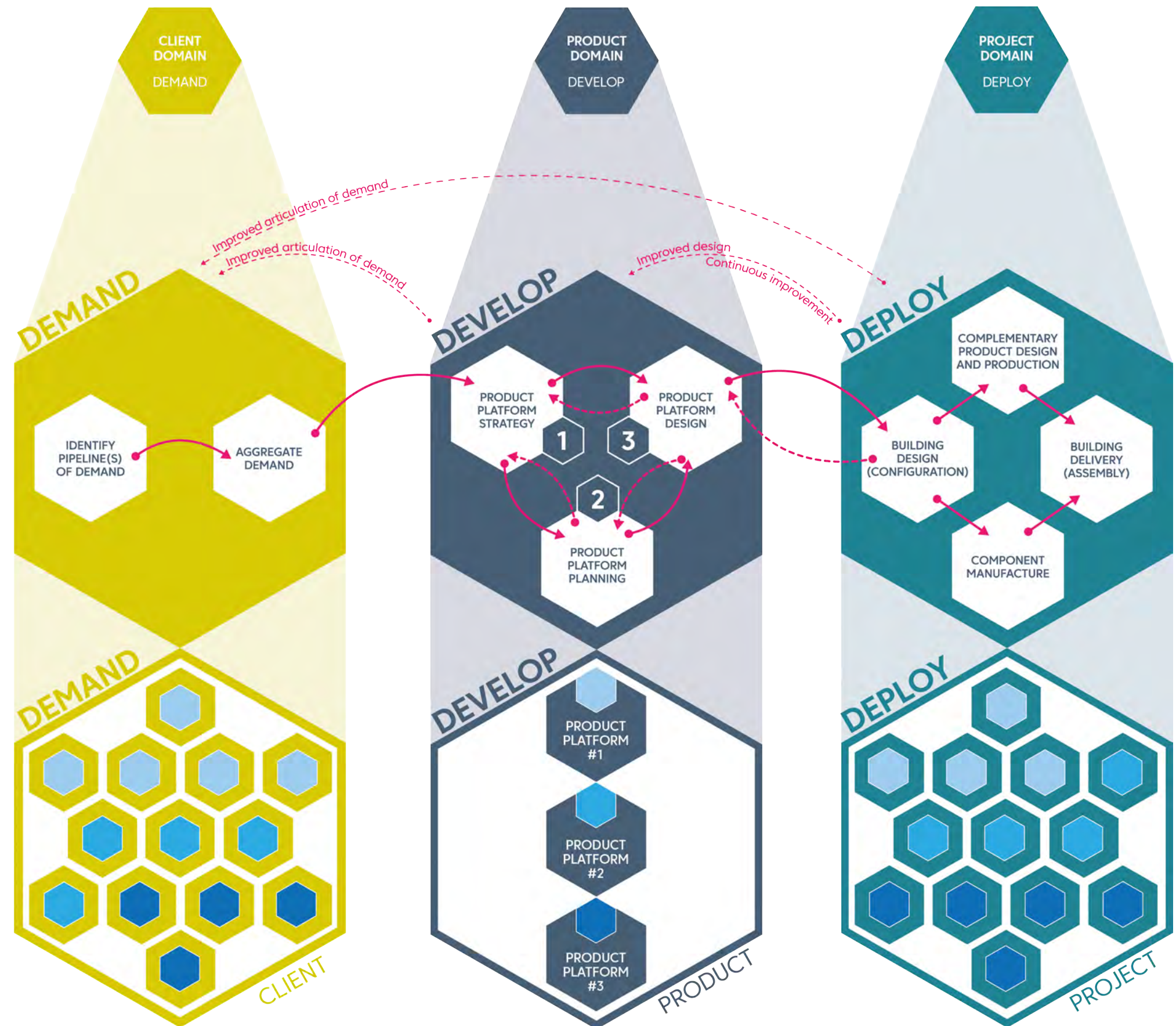

Fig. 3E: Product Platform Development Framework aligned to the three domains

AIM



To provide confidence to the supply chain that the solutions they develop will have a market.

The use of product platforms requires an aggregated demand, which is supported by harmonisation and rationalisation of design and information requirements across a range of asset types and client organisations.

OBJECTIVES

To identify future planned procurements and forecast needs including financial value and characterisation of procurement/ need.

To bring together the demand pipeline from multiple clients with associated technical requirements and value drivers so details can be segmented and analysed.

To provide long term performance feedback from operational assets to aid continuous product improvement.

To gather feedback from project and product domains on the suitability of pipeline data and requirements.

APPROACH

This is done collaboratively across the client base, away from the project environment.

Clients will need to agree on suitable time frames for the publication of pipeline and requirements data, balancing the need for continuous improvement with the need for stable demand (i.e. where requirements or pipelines are updated too regularly, Product Platform Providers could quickly find their products out of date.)

This pre-supposes that the demand has been harmonised and aggregated. Approaches to doing this are set out in the Hub's reports on [specification maturity](#) and [Defining the Need](#).

AIM



To respond to aggregated market demand through the development of a particular product platform that can be deployed across multiple projects and programmes.

OBJECTIVES

To set the strategic intent for a product platform.

To clearly understand the problem a product platform is aiming to solve.

To design a product platform, the supporting production environment, and how it will be deployed across multiple projects.

To provide adequate information to project and programme teams to support evaluation, selection, and deployment of the product platform including mechanisms for performance feedback.

APPROACH

It is expected that there will be multiple product platforms in the market serving different segments of the market.

The 'Rules' set out in chapter 2 provide a voluntary consensus framework that supports development of product platforms in a consistent manner, allowing clients to demonstrate compliance with any future government mandate for their use.

The next section (3.3) sets out detailed guidance for the development of a product platform which, where followed, demonstrate compliance with the rules.

AIM



To deploy one or more product platforms in a specific project or programme.

To shift, where possible, from design and construction to configuration and assembly

whilst managing interfaces with bespoke elements of design and on-site fabrication/ construction.

OBJECTIVES

To evaluate the suitability of available product platforms to project- or programme-specific requirements.

To configure selected product platform(s) by project or programme requirements.

To identify the extent and nature of bespoke design elements and manage interfaces with the selected product platform(s).

To manage manufacturing and assembly processes and their interfaces with any traditional construction operations.

To provide feedback to Product Platform Providers regarding the configuration, assembly (including interfaces) and, where possible, operational performance of deployed product platforms.

APPROACH

Project domain organisations will need to work closely with product platform providers from the very early stages of a project or programme to ensure effective incorporation of product platforms.

The exact role of project teams, the supply chain and the delivery model more generally may vary depending on the specific product platform – for example, for 'open' product platforms, the need to identify and manage suitable manufacturing capability may be increased when compared with a more vertically integrated solution.

Design and construction teams working in the project domain will need to consider the impact of increasing levels of pre-design and pre-fabrication on their current business models.

Note: organisations operating in the project domain may also be product platform providers.

Secure Information

Within the Product Platform Development Framework, it is vital that due diligence is applied to the security of data and information. With the growing use of digital technologies, the flow of information should be managed with a structured, security-minded approach in line with Rule 6 (Structured Information). This includes any information considered sensitive such as IP, commercial data or personal information. Appropriate security controls should be in place over the information and data that flows throughout **Demand**, **Develop**, and **Deploy**. Further information can be found [in this article](#).



Note: throughout the Product Platform Development Framework, CPQP provides a basis for a manufacturing-led approach to construction.

3.3. Product Platform Development



The use of platforms is a strategic choice to design once and use that design across multiple products. It is predominantly a financial strategy and is only one way to offer variety to customers and projects while reducing the cost-base; it is not universally applicable. Given the level of effort needed, the development of platforms should not be undertaken lightly or without understanding the financial case for doing so.

This section provides guidance, supported by current examples from industry, for those considering whether investing in the development of a product platform is the right approach for them. It focuses on the ‘develop’ section of the Product Platform Development Framework described in section 3.2 and does not cover activities undertaken in the ‘demand’ and ‘deploy’ sections (in terms of rationalising requirements, or the project delivery process). It does, however, set out the inputs required from, and outputs to be provided to, these activities.

Throughout, we refer to the Product Platform Provider (PPP) as the firm or consortium engaged in the development of the product platform under consideration.

The development process is split into three stages:

- 1. PRODUCT PLATFORM STRATEGY:** setting the strategic intent for the platform and determining whether a platform is the right approach. If it is, identifying where to play and how to win by maximising market leverage from a common technology.
- 2. PRODUCT PLATFORM PLANNING:** clearly defining the problem to be addressed by, and approach to, the proposed product platform before commencing design.
- 3. PRODUCT PLATFORM DESIGN:** designing the product platform itself and production and assurance processes (both on- and off-site) needed to deliver in line with the plan and strategy. Establishing ongoing management of the product platform and the method of deployment in projects.

The following sections take each of these critical stages in turn, describing the questions to be addressed, and the key outputs. It should be noted that these stages are linked, and Product Platform Providers will need to iterate between them during development.

INPUTS FROM THE CLIENT DOMAIN



As stated in the section ‘Future State Enablers’, “organisations across the client domain will need to work together to agree on common standards against which pipeline data and client

requirements are communicated”. A topic of current debate across the emerging product platform space is the extent to which rationalisation and standardisation should be undertaken within the client domain. The following sections are written in response to the following assumptions:

- That clients will work together to harmonise their requirements. This is, to articulate requirements in a consistent, standard format;
- That clients will work together to digitise their requirements. That is, to structure and publish requirements data against agreed data template(s);
- That clients will work together to rationalise, where appropriate, these requirements within and across sub-sectors or asset types, and;
- That clients will not specify (implicitly or explicitly) the products and processes required to address these requirements.
- That it will be the job of the market to determine how best to meet these requirements, whether through PPs or otherwise.

In accordance with the above, the Product Platform Provider’s key inputs from the client domain are a clear, longer-term and stable articulation of client demand (pipeline) and a set of harmonised – and increasingly rationalised – requirements associated with that demand. It is now the job of the Product Platform Provider to determine whether the development of a product platform will allow them to meet this demand more effectively and/or efficiently.

DEMAND: DETERMINING VALUE



The consistent use of the Value Toolkit across capital pipelines will improve the articulation of what is important to clients and how success will be measured. When combined with a process of harmonisation, digitisation and rationalisation, the information needed by a platform provider to develop a product platform becomes more accessible.

Value profiles – where produced away from any one project – can be aggregated to inform platform development, particularly where they can be combined with technical requirements and financial information across a pipeline. Depending on the level to which outcome drivers are rationalised, it will become easier to set performance targets for product platforms. A central mechanism to track, aggregate and publish value measurement within capitals would be helpful here so that the method of measurement can be understood by the market.

1 PRODUCT PLATFORM STRATEGY | INTRODUCTION

PRODUCT PLATFORM STRATEGY

A product platform strategy comprises the answers to two fundamental questions:

1. where to play, and
2. how to win in the pursuit of delivering variety at a lower cost.

Establishing the intent of the platform must come first, with the technical characteristics of any platform being amongst the last decisions to be made. Despite this, there may be a temptation for Product Platform Providers entering the world of product platforms to jump straight into the technical design – reflecting the current project-based mindset.

The platform strategy helps serve as a deliberate approach to maximising market leverage from common repeatable elements and processes, and minimising unplanned new product introduction. Undertaking new product introduction cycles instead of refining a product platform leads to increasing complexity in the product line. In a product platform, this effort can instead be utilised in continuous improvement exercises, increasing productivity.

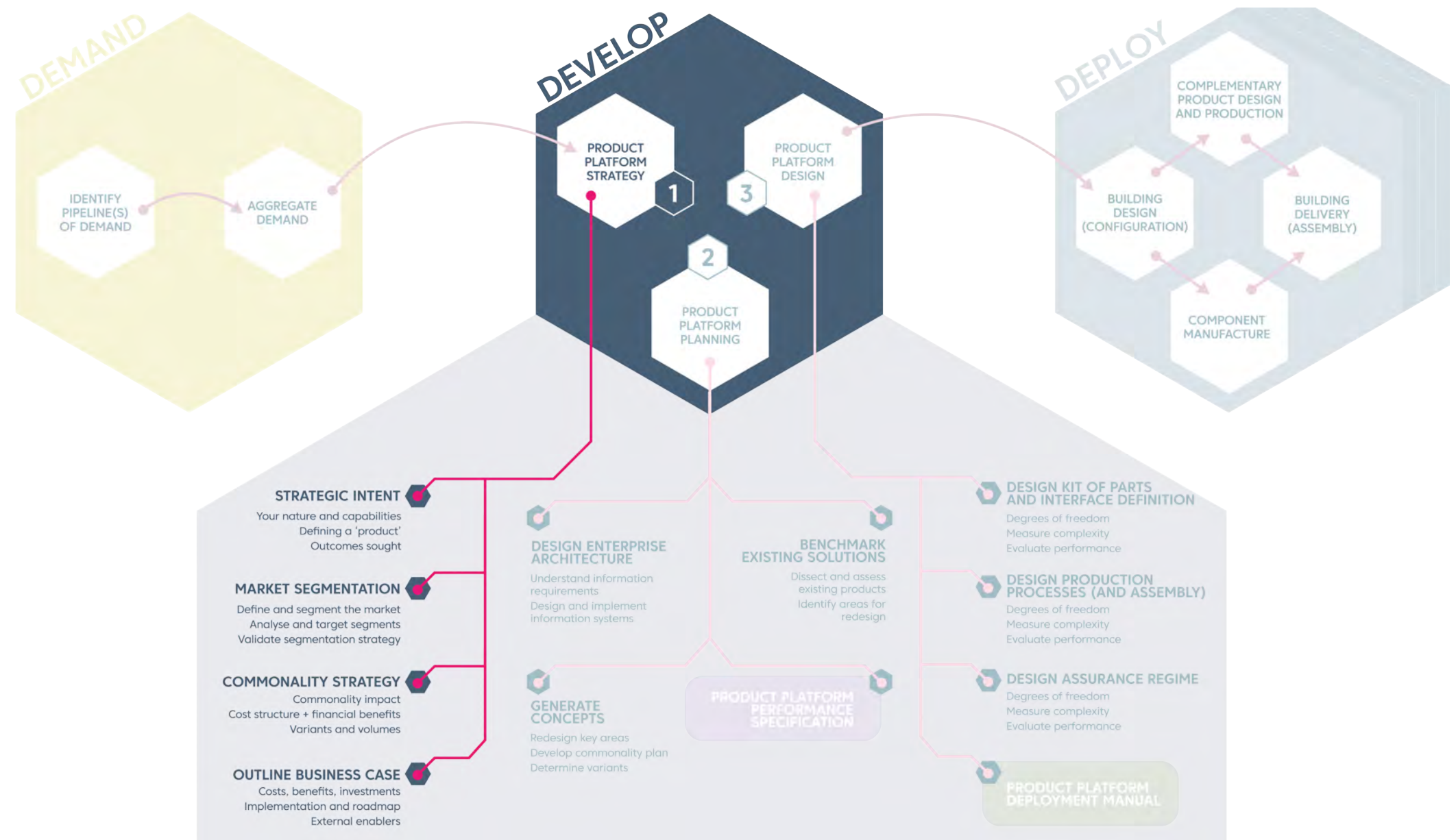

Fig. 3F: The core steps and activities underpinning the development of a product platform strategy

1 PRODUCT PLATFORM STRATEGY | STRATEGIC INTENT

STRATEGIC INTENT

The first step of the product platform strategy is to define the overall strategic intent of the product platform. This is predicated on three main factors:

YOUR NATURE AND CAPABILITIES: The nature and capabilities of the organisation(s) developing the product platform - the Product Platform Provider. Including what the Product Platform Provider sells, to whom, with what cost structures, and aspirations for the future.

DEFINING A PRODUCT: The definition of 'product' as it relates to the output of the proposed product platform and resulting interfaces - both technical and non-technical - with other products, systems, people, processes and services.

OUTCOMES SOUGHT: The outcomes the Product Platform Provider seeks to gain from developing a product platform - whether economic, such as enhanced revenue through an increase ability to deploy new products) or cost saving (through efficiencies, economies of scale), environmental or social benefits need to be clearly defined as a fundamental to the Product Platform Strategy.

A clear vision of the intended outcome is critical to establishing a business case for investment, resource and co-ordination required. This strategic direction will equally aid and inform decisions regarding commonality, sharing and distinctiveness during the development of the product platform and thus needs to be clearly defined.

DEVELOP: DETERMINING VALUE

You should be able to identify a line of sight from the earliest stages of **Develop** through to the outcome profiles across an aggregated **demand**. It may be useful to identify the contribution that the key repeatable and complementary components, processes, and organisations make to outcome profiles and focus development efforts and metrics accordingly. Where possible, providers may benefit from the use of balanced scorecards for key decisions to ensure the most beneficial options are taken forward. For example, system and material choices may be driven by a prominence of natural capital in value profiles for target segments, whereas production facilities and methods may be driven by a prominence of human capital. Consider any tests or certification and factor this into planning and design stages (costs, time and benefits). Ensure that value-related metrics are available for deployment, so the contribution of a product platform to a project value profile is easier to calculate.

Fig. 3G: Using a design structure matrix (DSM) can be valuable in defining product (purple) and high-level interfaces (other shading) for a product. With all the component types of a building listed along each axis, you can concentrate on one component at a time and consider its interfaces with all other components. Components that are part of the product will need to be linked by an internal interface, while other interfaces will be external. Having identified which components should form part of the product (left, with the chosen product in purple) you can then rate the importance of each other interface (right) according to sensitivity and connectivity

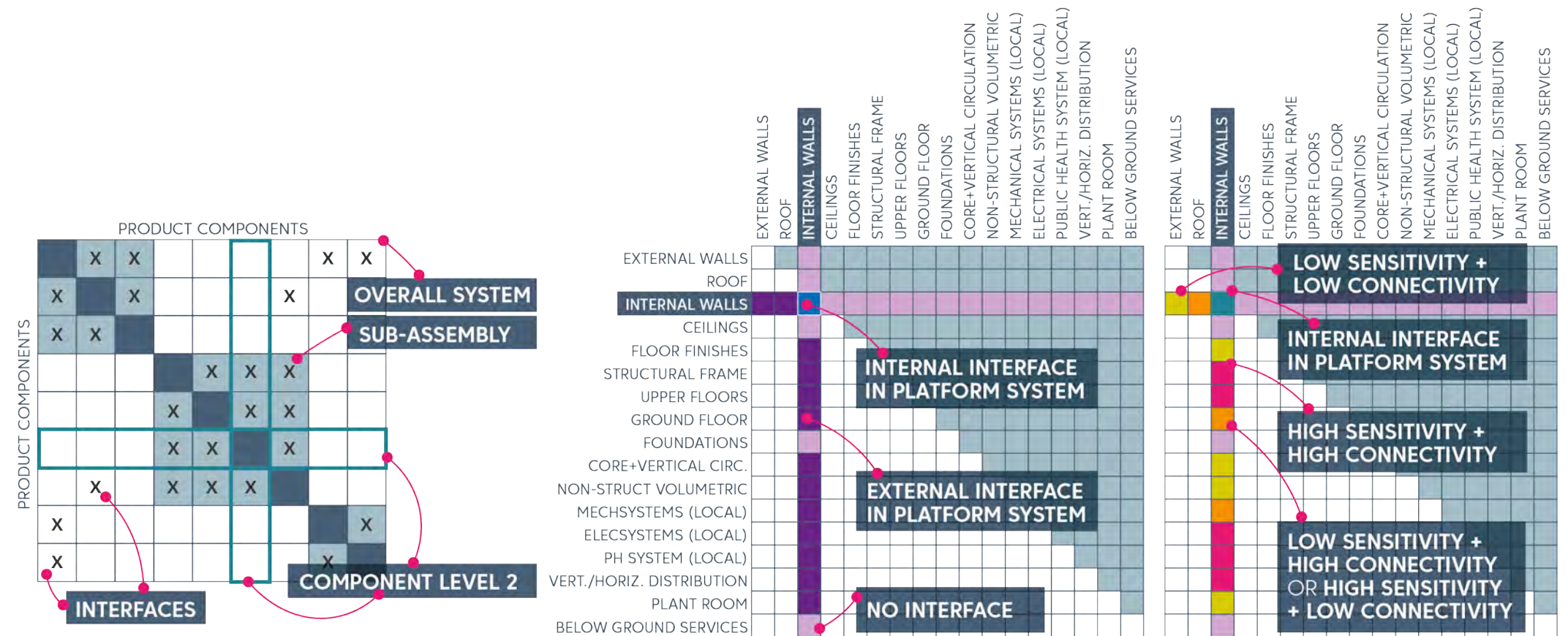

Fig. 3G: Using a DSM to define Interfaces with other systems

1 PRODUCT PLATFORM STRATEGY | STRATEGIC INTENT

DEFINING A 'PRODUCT'

Defining a 'product' in the context of construction is inherently more difficult than for other sectors but is critical to successful execution of the PP development process.

For the purpose of this guidance, 'the product' is defined from the Product Platform Provider's perspective; being the final configuration of core repeatable and complementary components which are deployed into a project. The collection of product variants is the product family.

Depending on the type of product platform being developed, 'the product' may manifest as anything from complete buildings to the constituent parts of an MEP system. Each deployment of the product platform into a project represents a product variant and together these variants make up a product family.

When defining and determining a product, it is important to understand the nature and source of any waste associated with the product, so that this can be minimised during the rest of the development process.

In determining the above, the Product Platform Provider can now determine the role, or roles, it wishes to play – and by extension, the role of other parties - in the development and deployment of the product platform.

We have identified several different models to illustrate the role of a given product platform in the market. While these models do not describe all possible scenarios, they do clearly articulate how strategic intent influences a Product Platform Provider's approach to the rest of the development process.

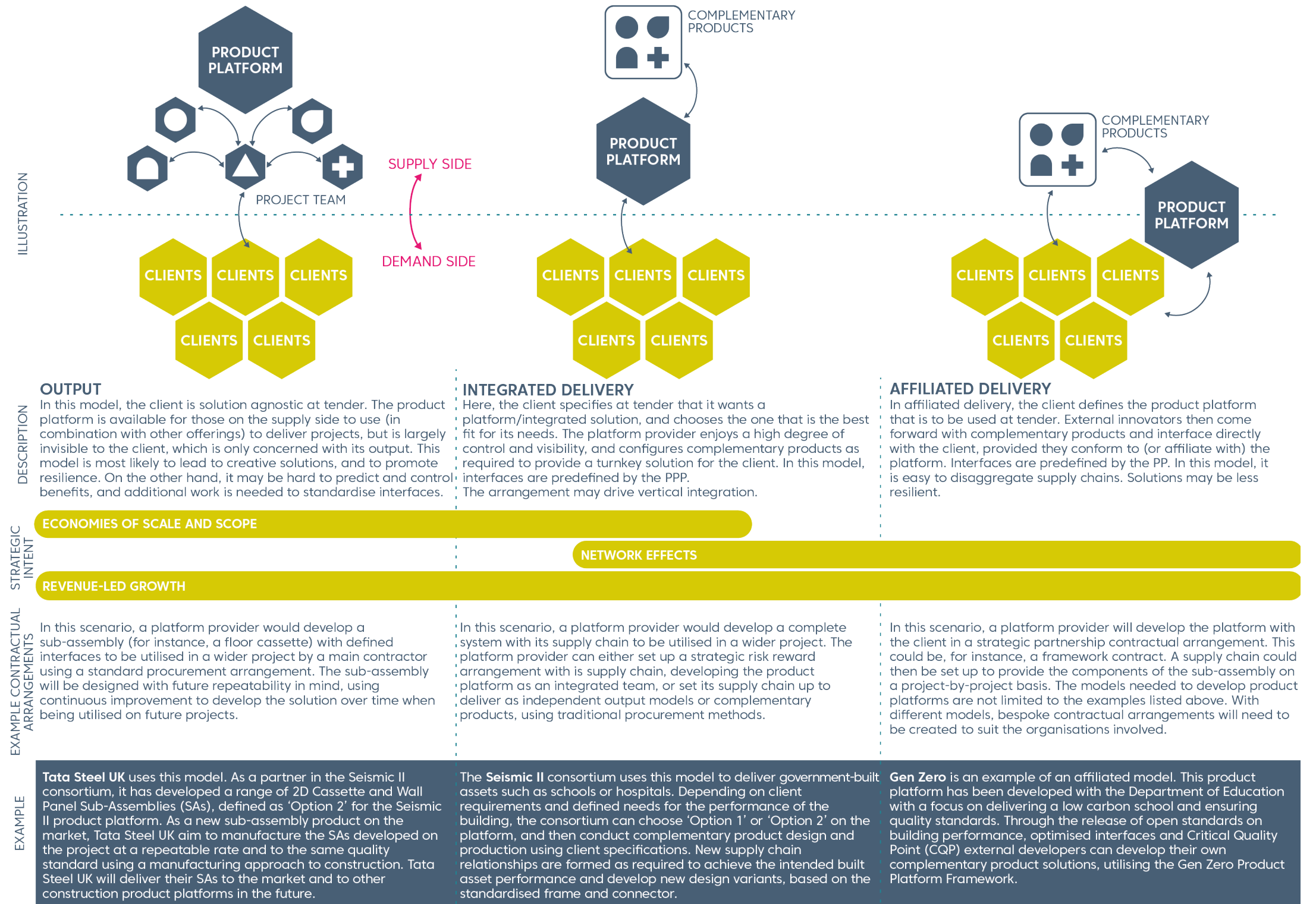

Fig. 3H: Three possible models for a product platform in construction.

In the output model, the platform is invisible to the client. In the integrated delivery model, the client interfaces with the platform but not its complementary products, receiving a turnkey solution. In the affiliated delivery model, the client is committed to the platform and its complementary products and engages partners who can work with it.

1 PRODUCT PLATFORM STRATEGY | MARKET SEGMENTATION

MARKET SEGMENTATION

Market segmentation is used to group market opportunities (construction projects) according to common requirements or attributes, with the aim of identifying the right segment(s) to focus on. How a Product Platform Provider defines the market will be directly influenced by the strategic intent. Where the Product Platform Provider includes a client, the total addressable market may be restricted to their own pipeline.

The market segmentation exercise can take many forms, with different industries taking different approaches according to the nature of the product and the structure of the market(s) they serve. The following approach is suggested as a robust starting point for the construction industry but it is recognised that the Product Platform Provider is likely to have an existing understanding of the most effective way to look at the market.

DEFINE AND SEGMENT THE MARKET

First, the Product Platform Provider must establish who wants what, how much of it, and when and how they intend to buy it. The total addressable market represents all those projects that will be delivered within a given time frame, likely covering different clients, procurement routes and asset types, likely categorised by construction sub-sector (healthcare, education, commercial etc.). The Product Platform Provider may wish to rank or rationalise these sub-sectors based on their current market presence or access. As described above, where the Product Platform Provider is or includes the client, the scope of this exercise is likely to be significantly reduced.

With the total addressable market identified, the Product Platform Provider must now look to group – or segment - project opportunities in a manner relevant to the nature of the PP. Typically, this is done by identifying technical factors which drive cost, and these will vary depending on the type of product platform being developed. For example, the cost of a building structure is typically driven by the volume of the internal spaces. However, the cost of MEP systems is more likely to be driven by the conditioning needs of those spaces. It is also likely that the same grouping exercise will be undertaken from other perspectives, such as procurement route or production approach (e.g. offsite construction maturity). As such, Product Platform Providers will need to consider multiple driving factors before reaching an appropriate grouping.

ANALYSE AND TARGET SEGMENTS

Before deciding which groups or segments to target, the Product Platform Provider should determine the role the proposed PP is likely to play in driving total project cost in each segment within the visible timeframe. This can be done by considering the percentage of total project cost represented by the PP and the extent to which it may influence the remaining cost (see Fig. 3J). This exercise identifies where the PP is likely to be most effective and highlights the different approaches that may need to be taken in different parts of the market. For example, market segments where the PP is a dominant element of total cost and has a significant impact on the cost of other elements are likely to be more attractive than those where it represents a small proportion of total project cost and is highly affected by other elements. For clients looking to develop PPs without an initial technical position/bias, this exercise can be undertaken in a solution agnostic manner to inform their approach.

With any ‘unattractive’ market segments removed from the analysis, the remaining segments should now be analysed with regard to aspects such as market size, growth and stability, performance trends, competition and market share.

Drawing on the completed analysis, the Product Platform Provider can now select its target market segments. Depending on the Product Platform Provider’s strategic intent, they may approach this in one of two ways: a top-down approach will drive them to consider the type of projects, assets, or procurements they wish to target, leading to consideration of what needs to be done to address them. Alternatively, a bottom-up approach will drive them to consider the segments they already serve, with consideration for additional segments with similar characteristics or requirements.

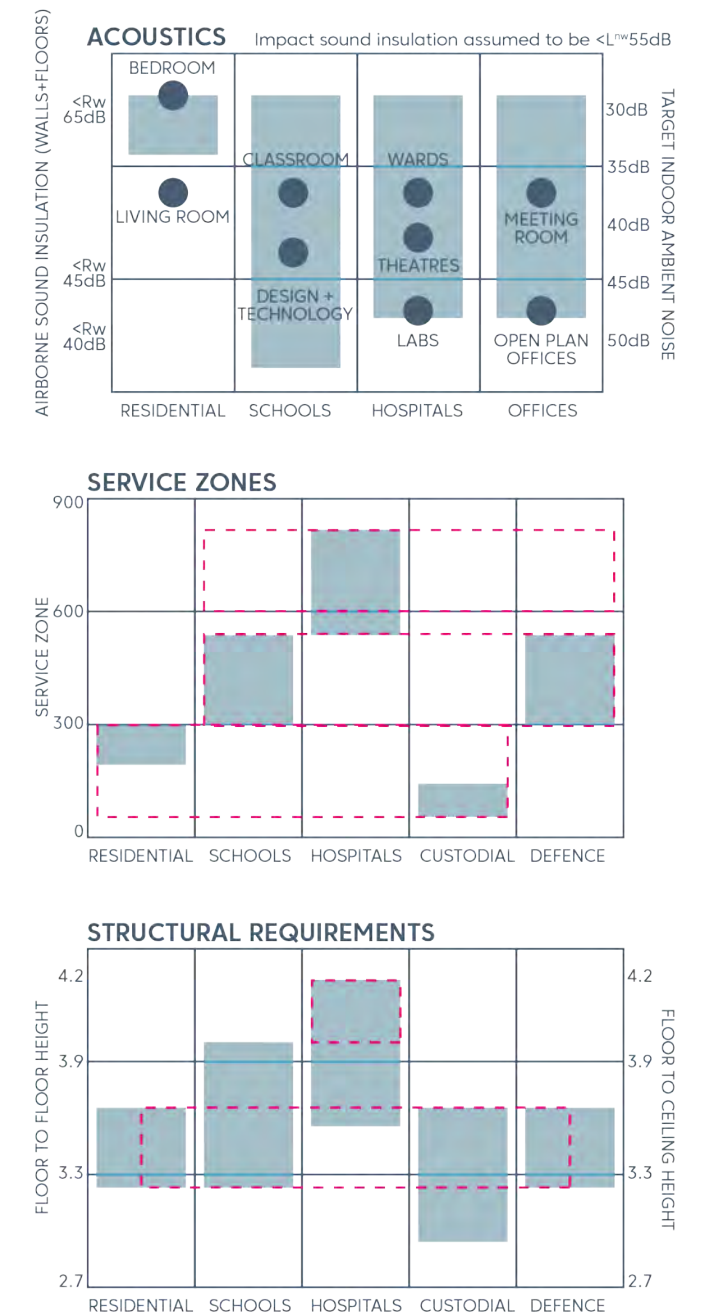

Fig. 3I: A selection of segmentation grids, covering different lenses for different PP types

1 PRODUCT PLATFORM STRATEGY | MARKET SEGMENTATION

Fig. 3J: The different systems are ranked by their contribution to project cost (left) and the influence that they can have on other elements and systems in target segments (right).

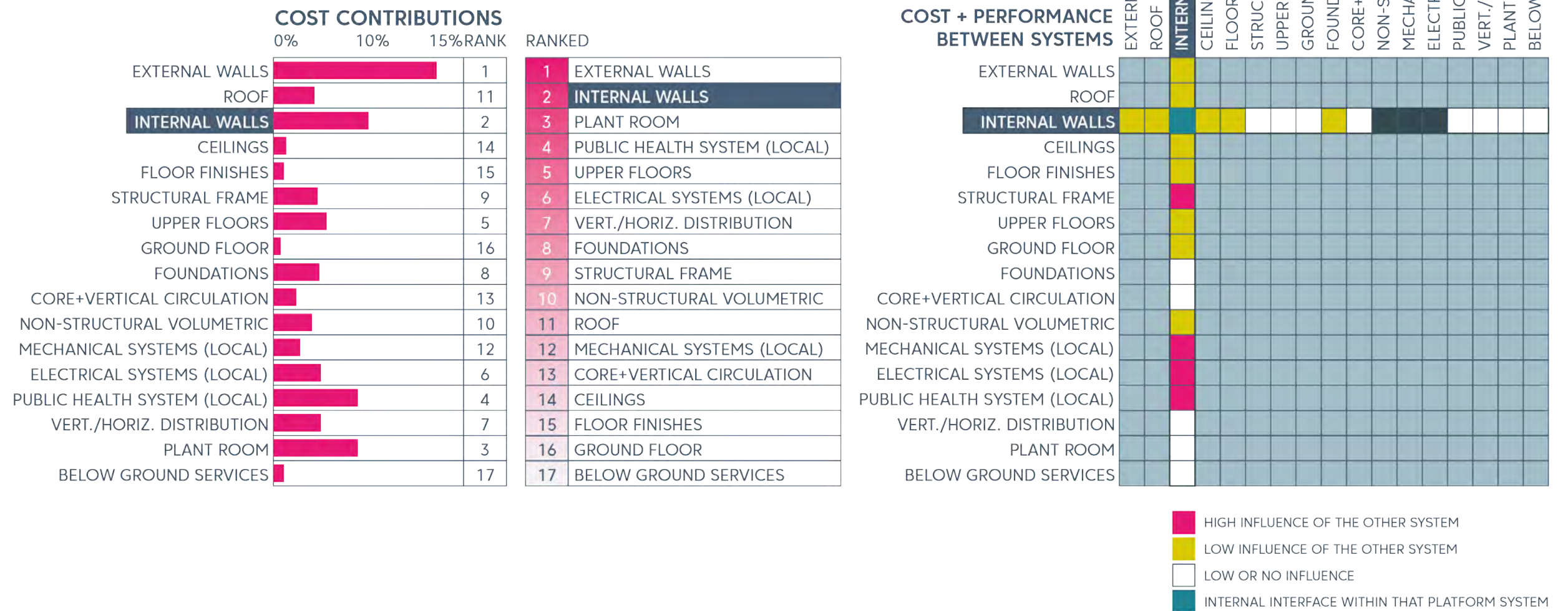

Fig. 3J: Ranking systems by their influence and contribution to project cost

VALIDATE SEGMENTATION STRATEGY

If required, further detailed analysis of each target segment may now be undertaken – likely through more direct engagement with the market - to understand the financial opportunity associated, current market players and typical technical solutions. This exercise should also provide an initial understanding of the value drivers, pain points, regulations and standards etc. for each target segment which will provide a starting point for later planning activities.

With detailed analysis complete, the market segmentation strategy should be reviewed and refined, checking for alignment with the strategic intent. This may take multiple iterations, but time spent here is likely to be critical to the development of a successful and sustainable product platform.

Here are some considerations to guide and supplement this process:

1. Consider how many segments can realistically be served in terms of the capability and capacity of the Product Platform Provider – noting the role(s) it intends to play (according to strategic intent)
2. Take early note of the trade-off between commonality and variability. Tackling too many segments may result in unacceptable levels of commonality for clients or, conversely, insufficient commonality to make a product platform viable.
3. Consider the stability of market segments. PPs are long-term investments and the dominant drivers for a given segment may change over the lifetime of the product platform (e.g. how affected might a segment be by the drive to net zero?). Where identified, such changes are likely to affect a Product Platform Provider's investment profile and associated technology roadmap. Where not accounted for, product platforms could become obsolete earlier than intended.
4. Consider any strategic relationships that may need to be formed in order to execute the segmentation strategy.
5. While this section describes the process of selecting multiple market segments, it is entirely possible that a given segment presents a sufficiently large and stable opportunity to warrant it being the sole focus of a PP. Similarly, the segment or segments targeted may reflect the capabilities or capacity of the Product Platform Provider.

1 PRODUCT PLATFORM STRATEGY | COMMONALITY STRATEGY

COMMONALITY STRATEGY

With target market segments selected, and with an understanding of the timeframes associated with the projects within these segments, the Product Platform Provider must now develop an outline commonality strategy (what to make common and why). This exercise provides an initial view of the extent to which components, processes and relationships can be common – or shared – across target segments and where variants may need to be developed. Doing so also provides an early indication of the level of investment (capital, time, effort, capability) required by the Product Platform Provider which may lead to a revision of the target segments.

The commonality strategy seeks to establish how commonality helps the Product Platform Provider to realise its strategic intent through the correct blend of:

- **revenue benefits**, such as the ability to deploy new technologies, find and serve niche requirements, and reducing the time to market;
- **cost reduction**, such as sharing development and testing costs, economies of scale, amortising fixed costs and reducing inventory;
- **risk reduction**, such as increasing quality, reduced susceptibility to changing requirements, and improved management of spare parts for production.



Blind attempts to share as much as possible without regard for expected benefits and costs are likely to incur costs which far outweigh the benefits.
(based on Cameron, B.G., Crawley, E.F. (2014). Crafting Platforms for Outweighing the Benefits and Costs. In: Simpson, T., Jiao, J., Siddique, Z., Hölttä-Otto, K. (eds) Advances in Product Family and Product Platform Design. Springer, New York, NY. See links in Section 6, Best Practice

Fig. 3K: The aims, benefits and risks from commonality

1 PRODUCT PLATFORM STRATEGY | COMMONALITY STRATEGY

A key distinction between a platform approach and a traditional approach is the ability to mass customise products. This means leveraging higher volume manufacturing methods to create products which are tailored to meet the needs of individual projects.

In doing so, a platform can develop different products more effectively, growing market share and increasing the flexibility and responsiveness of offerings. The key is to balance commonality with variability in a way which outwardly creates differentiation, but inwardly enables economies of scale. We therefore need to understand what needs to vary (or be distinctive), and what can be common.

Variable attributes are those which customers deem to be important in distinguishing between products and projects. Customers expect differences between these attributes in different spaces and different buildings. An example might be the layout of a building, the dimensions of a space, or the fixtures and finishes for different walls in a classroom.

Common attributes are those which customers do not necessarily interact with or notice. An example might be the form of construction of a floor or the make-up of a façade.

Variable and common attributes are related – for example the dimensions of a space are related to the form of construction to some degree – but they are fundamentally different ways of describing aspects of a building.

The relationship inevitably involves a trade-off. Variability increases appeal to customers, but may also increase cost. The commonality strategy is central to successfully achieving this trade-off. A strong commonality strategy needs to address four key areas:

- **Technically feasible** – it must be technically possible to deliver variable attributes within and across target segments with common repeatable elements;
- **Financially beneficial** – there must be a financial benefit, consistent with the strategic intent, to developing and deploying these common repeatable elements within and across the target segments;
- **Acceptable to the market** – that the common repeatable elements offer a benefit to the target segments, that any trade-offs needed (for example through more constrained solutions) are acceptable, and that variability is realised where required; and
- **Organisationally possible** – the Product Platform Provider must be able to deliver the PP, including having the right capability (skills, know-how), capacity, culture and governance (for example establishing clear decision rights, co-investment and deployment across projects or profit and loss groups) since platforms require multiple functions to work together.

The following process is recommended for developing the commonality strategy:

- Test the market;
- Quantify cause-effect relationships;
- Assess technical feasibility and platform extent.

TEST THE MARKET

Building on the high-level exercise completed as part of strategic intent, the Product Platform Provider should now develop a more detailed understanding of their product's 'touchpoints'. Exploration of these touchpoints will be used to understand the extent to which commonality is desirable and achievable within and across their target market segments. Typical touchpoints may include:

- **Touchpoints with other products:** which other building products and systems might the PP interact with and how? *Note: This activity builds on the high-level view of interfaces defined as part of strategic intent and helps understand technical feasibility.*
- **Touchpoints with other delivery processes:** which construction, procurement, assembly or disassembly processes might the PP interact with? Where might there be opportunities for continuous improvement or better use of supply chain capacity? Which skillsets are needed in delivery? With whom does the Product Platform Provider exchange information during delivery, in what way and for what purposes? *Note: this activity helps understand technical feasibility and financial benefit.*
- **Touchpoints with asset users:** who will be interacting with the PP through all lifecycle phases, from the capital delivery phase through to operations, maintenance and eventual decommissioning? What are the information requirements from the 'product'? *Note: this activity helps understand acceptability in the market.*

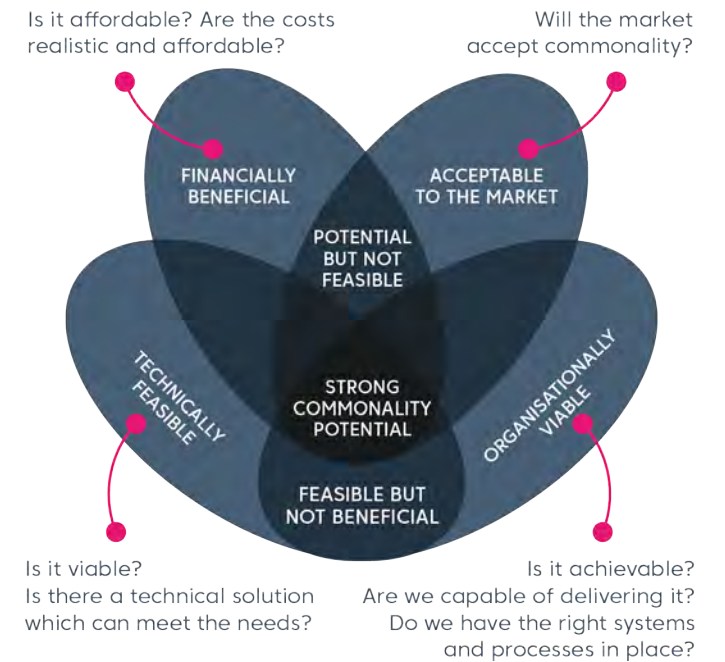

Fig. 3L: Key factors to a successful commonality strategy

Within each target segment, the PP should consult relevant stakeholders (i.e. representing the identified touchpoints) to understand where there is a perceived benefit to commonality and where there is a perceived need for customisation in the context of project opportunities within that segment. In some cases, it may be necessary to consider the benefits or barriers to commonality across segments (for example where clients operate in multiple segments) though this is likely to be less common in a construction context. Product Platform Providers should elicit as detailed a response as possible, potentially employing techniques such as the '5 whys' to help distinguish between actual and perceived needs or barriers.

Barriers and benefits may be assessed within a project (for example across a range of buildings on one site), across projects (for example across different buildings in the same estate) and across segments (for example across different estates).

1 PRODUCT PLATFORM STRATEGY | COMMONALITY STRATEGY

QUANTIFY CAUSE-EFFECT RELATIONSHIPS

With an understanding of touchpoints, the Product Platform Provider can use tools such as cause-effect (or fishbone) diagrams to establish possible effects of variability in products (i.e. a lack of commonality) on increased levels of activities and use of different resources in development and production (both on and off site).

An example of this can be found in Fig. 3M which shows a cause-effect diagram for delivering three unique frame systems across three projects, showing elements in the product and process that can be assessed for cost of variety.

This helps to identify key areas of focus for commonality to help realise targeted benefits. It is an iterative exercise, and you may need to return to test the market repeatedly each time changes are made.

By tracking the effects of variability along activities and resources, we can identify a possible commonality strategy to address each cause. The cost structures identified at the outset may be useful here in breaking down and assigning costs for each cause. This provides the Product Platform Provider with relevant cost information as to which part of the product might yield the greatest financial benefits through having a PP.

The focus of this activity may be on the PP itself and/or on other systems downstream – for example: a product of high value but low influence on other systems should focus on the PP, whereas a less valuable but more influential product should focus on other systems.

ASSESS TECHNICAL FEASIBILITY AND PLATFORM EXTENT

Having understood the variability desired by the market, and the relevant cost data, the Product Platform Provider can perform a high-level assessment of the technical feasibility of developing common elements (components, production processes, operating procedures) to support the realisation of financial benefits. This can make use of the activity-based costing performed above.

The following approaches may be useful in addressing cause-effect relationships:

- **Modularity** – focusing on the functionality which is assigned to sub-assemblies (collections of components) with variety achieved by combining different sub-assemblies and variants of sub-assemblies. This allows variety to be isolated and multiple functions can be assigned to one sub-assembly. Interface design therefore becomes critical.
- **Commonality** – focusing on reducing the number of unique elements without sacrificing variety. This can enable the same production processes to be used to make different products.
- **Standardisation** – focusing on commercially available, off the shelf components (in most cases cheaper than custom components).
- **Consolidation** – focusing on integrating several parts or materials into one that requires fewer distinct activities or less equipment to process.
- **Delayed differentiation** – focusing on maintaining commonality of components processes for as long as possible, with variability introduced as late as possible.
- **Reusability** – focusing on deliberately reusing existing elements (components, processes and so on) for new products.

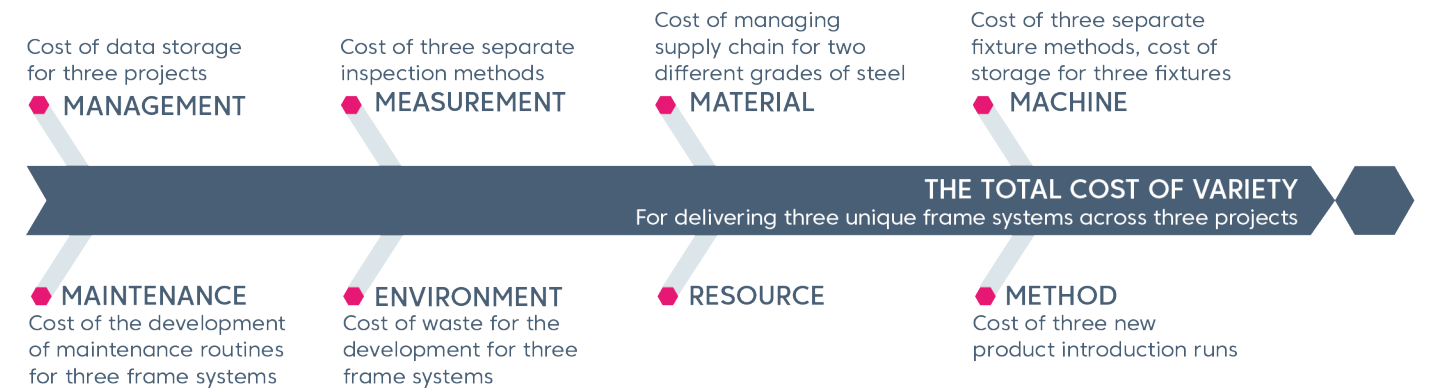

Fig. 3M: Cause-effect relationships for a PPP delivering 3 unique frame systems across 3 projects

This technical assessment can be used to define the intended ‘reach’ of a given PP or to inform the need for multiple platforms to be developed. Where requirements across target segments differ too much, it may not be practicable to develop a single product family which meets the requirements whilst being financially beneficial. In this case the Product Platform Provider may need to create multiple product families (and hence multiple PPs). Conversely, it may prove possible to target further segments with one family.

DEVELOP OUTLINE COMMONALITY STRATEGY

Reviewing progress to date, the Product Platform Provider:

- **has grouped ‘attractive’ and accessible project opportunities** according to common requirements;
- **understands the acceptable level of commonality** and expected level of customisation within those groups;
- **has identified key opportunities** for financial benefits;
- **has assessed the technical feasibility** of these opportunities;
- **has identified any refinements** required to the segmentation strategy.

By reviewing this information, the Product Platform Provider can develop an outline commonality strategy. This will need to cover **technical, organisational, market** and **financial** aspects.

COMMONALITY STRATEGY

TECHNICAL: the common components and production processes that will make up the PP and the range of performance and requirements which will be met for target segments. Note that while increased commonality makes production processes more efficient, pushing commonality too far may lead to inefficiencies in deployment.

ORGANISATIONAL: the capabilities, resources and relationships that need to be secured by the Product Platform Provider if they choose to proceed with PP development and inform the outline business case.

MARKET: the target segments and extent to which the common elements can be shared across them. This will be picked up in more detail during the development of the Product Platform Roadmap. Take note of areas where commonality of elements may unacceptably limit customer choice or performance of the asset in use.

FINANCIAL: The targeted financial benefits and how commonality will deliver these. The Product Platform Provider should be checking the financial benefits against the most dominant areas of their current cost structure (as identified as part of the strategic intent).

1 PRODUCT PLATFORM STRATEGY | DEVELOP OUTLINE BUSINESS CASE

DEVELOP OUTLINE BUSINESS CASE

Based on the outline commonality strategy, the Product Platform Provider can now generate a preliminary business case for the proposed PP. This may serve as the basis for a formal stage gate review for the development project, determining whether there is a sufficiently strong case for continued investment. The Product Platform Provider should now have gathered sufficient intelligence to set out:

- **The revenues expected from the selected target segments** – representing the likely share of project opportunities across the target segment that are expected to be served by the PP and the timeframes for these opportunities.
- **The costs and benefits (financial and non-financial)** associated with sharing components, processes and relationships together with an understanding of alternatives (not involving a platform), and the associated financial targets for the PP.

How the approach delivers on the strategic intent.

- **The level and type of investment required** to develop the PP(s) and supporting capabilities needed to serve those segments, and the approximate timeframe over which that investment will be needed.
- **Key metrics and measures of success**, including compliance with Rules and adherence to Principles.

The business case should also set out how the Product Platform Provider will go about implementing the strategy, including key milestones and accountability, key risks (including dependencies) and appropriate mitigation, and key success criteria.

PRODUCT PLATFORM ROADMAP

The Product Platform Provider now needs to define its planning horizon: how far into the future is it planning for (relative to the longevity of the repeatable elements) and which opportunities fall into this horizon? This enables it to focus on part of the pipeline of demand and account for known changes in regulation or requirements (such as targets progressively driving towards net zero) and to identify the order in which different product families will be developed.

The output of this activity is a Product Platform Roadmap. This is a detailed breakdown of activities to inform planning and investment decisions, that sets out the order in which the Product Platform Provider needs to develop product families and constituent parts.

EXTERNAL ENABLERS

The business case needs to clearly identify any key conditions or enablers which need to be in place for the PP as planned to be viable, with the roadmap highlighting any phasing and dependencies. Key considerations for this are shown below.

KEY CONSIDERATIONS

TECHNICAL: key dependencies and requirements for other key systems, particularly those which dictate requirements for the PP.

FINANCIAL: procurement conditions; warranties and liabilities and insurances; tolerable ranges in material, labour and capital prices as applicable.

MARKET: predictability of demand (in both volume and nature)

ORGANISATIONAL: capability and capacity of the Product Platform Provider's supply chain, which may be affected by the Product Platform Provider's position in the supply chain and the role which the PP is intended to play (output, integrated or affiliated). Cooperation needed with other PPs during development and/or deployment, including where working with other systems is needed to function as a whole building.

2 PRODUCT PLATFORM PLANNING | INTRODUCTION

PRODUCT PLATFORM PLANNING

PREREQUISITES

Before proceeding to product platform planning, Product Platform Providers should first reflect on the completed product platform strategy; ensuring they have a clear and collective understanding of the following:

1. The target market segments the Product Platform will address.
2. How and when those target segments will be addressed.
3. A bounded definition of 'product' in the context of the PP.
4. How the 'product' will need to change to meet requirements across target segments* (product 'variants').
5. The external interfaces and dependencies that need to be managed to allow successful deployment of the PP into projects.
6. The need to develop additional platforms to serve all the product variants within and across targets market segments.
7. A clear understanding of where commonality in the product is beneficial and where variability is required or expected.
8. Financial targets for the platform and an outline strategy for how commonality will enable realisation of these.
9. A defined lifetime for the product platform and ordered priorities for any key developments required over this period.

If any of the above is unsatisfactory or unclear, the proposed platform may need to be rethought or an alternative strategy pursued.

**Accepting that specific project requirements may not be available at this point*

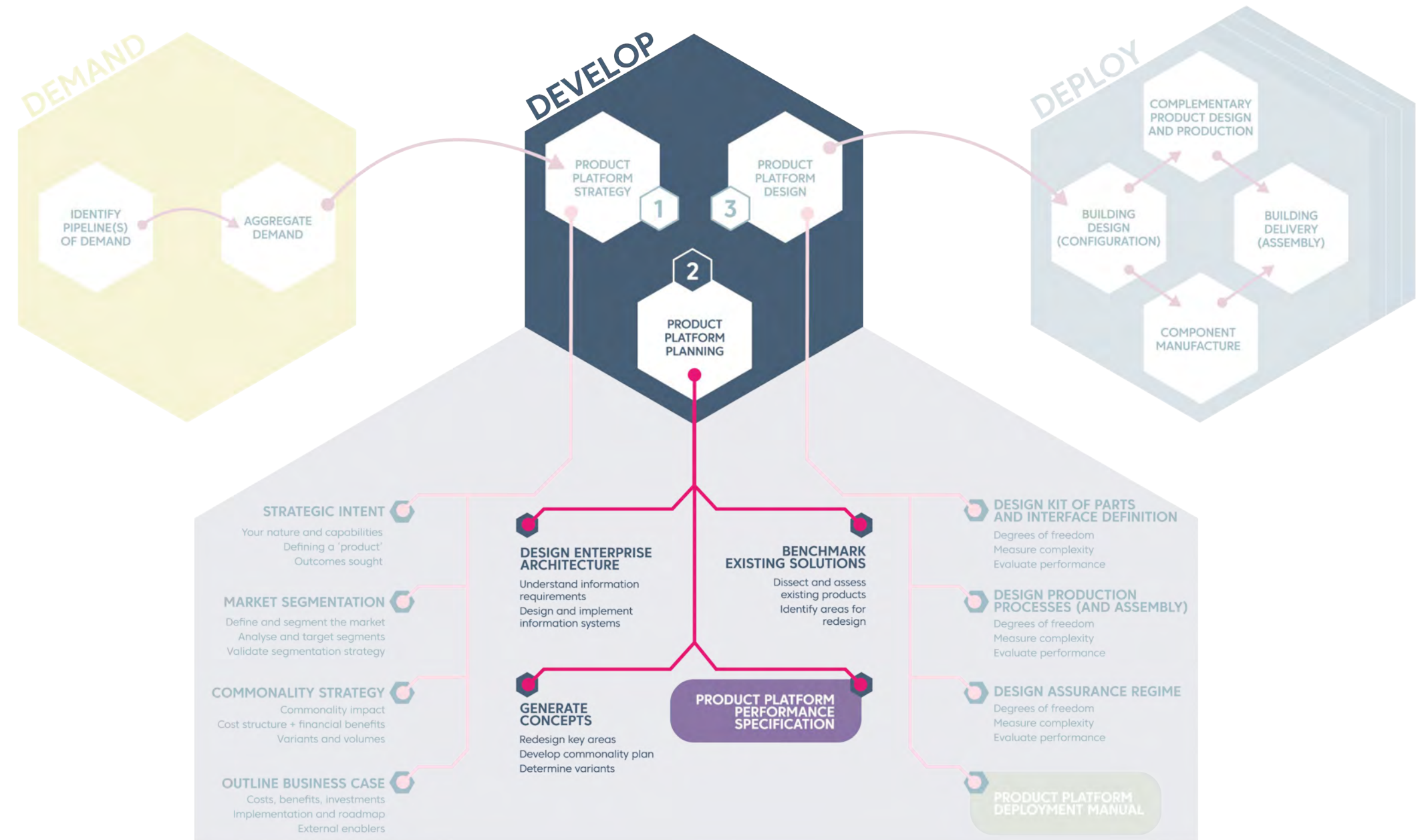

Fig. 3N: Product Platform Planning

Having determined that a platform is the right approach and established its strategic place in the market, the planning stage consists of clearly defining the problem to be addressed by the platform, and drawing up a plan for how it will operate.

The steps involved in this process include setting the information requirements and information management systems that the platform will need (enterprise architecture); benchmarking existing products to assess where the designed platform could improve performance; and generating concepts for design in these areas.

The output of this planning activity is the product platform performance specification, which will inform the next stage, product platform design.

2 PRODUCT PLATFORM PLANNING | DESIGN ENTERPRISE ARCHITECTURE

DESIGN ENTERPRISE ARCHITECTURE

Successful implementation of the product platform strategy will be dependent on having the correct information management processes and systems in place, and on keeping these up to date during development and deployment.

Enterprise architecture represents the hardware and software systems needed to collect, process, store and distribute information needed over the life of the product platform. This may include (but is not limited to) the following:

- Business Intelligence
- Customer Relationship Management (CRM)
- Enterprise Resource Management (ERP)
- Product Data Management (PDM)
- Requirements Management
- Supply Chain Management (SCM)
- Manufacturing Execution Systems (MES)
- Specific or specialist software

The specific nature and arrangement of these systems will be dependent on the needs and nature of the Product Platform Providers (e.g. single organisation or consortium) and needs to be periodically reviewed to ensure continued relevance.

The following steps are suggested as a good starting point for those new to defining and developing enterprise architectures:

1. Understand your organisational, operational information requirements.
2. Understand your existing systems, workflows, and integrations.
3. Understand information requirements of typical projects and associated clients.
4. Set product and production information requirements:
 - External (what clients, projects and others in the supply chain need from me and what feedback I want to gather);
 - Internal (what I need to organise myself and undertake my activities);
 - Different systems from different vendors, and which integrations are needed to fulfil which workflows across enterprise, management, supervisory, control and field/machine levels as appropriate.
5. Design information systems to suit.
6. Implement according to roadmap.

Working in collaboration with Cardiff University, the Hub has developed a [Digital Compliance Ecosystem \(D-COM\)](#) as a demonstrator of these principles. D-COM is intended to bring tangible benefits such as:

- Greater certainty that all regulatory requirements are being met
- Reduction in time and resources spent in investigating the root causes of failure
- Increased transparency through the central collection, and management of compliance data for the UK construction industry
- Improved auditability provided through digitised compliance processes.

“The purpose of Enterprise Architecture is to optimise across the enterprise the often fragmented legacy to processes, into an integrated environment, that is responsive to change and supportive of the delivery of the business strategy

The Open Group Architecture Framework (TOGAF)

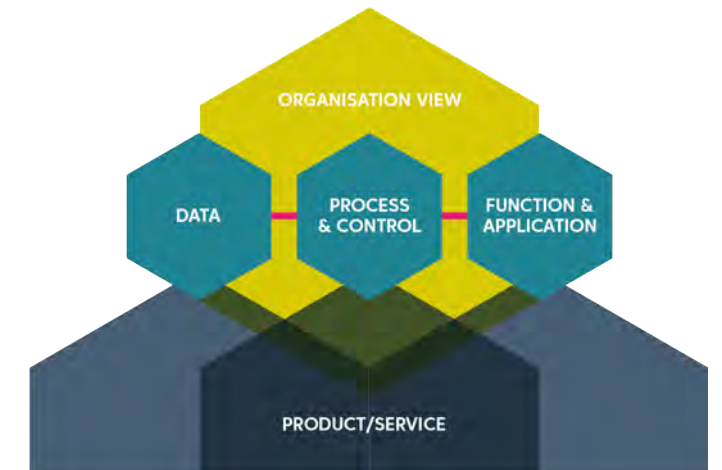

Fig. 30: Information systems, adapted from [ARIS Platform](#)

BENCHMARK EXISTING SOLUTIONS

The focus of benchmarking is to inform where the Product Platform Provider’s efforts are best focused to realise benefits through the PP. The exercise requires Product Platform Providers to identify, assess and compare ‘representative solutions’ - concentrating on the initial product family(ies) identified in the Product Platform Roadmap (developed as part of the product platform strategy process).

Representative solutions should ideally be those the Product Platform Provider already supplies into these segments along with those of competitors. However, the Product Platform Provider may choose to use hypothetical or ‘typical’ solutions where such reference data is not available.

Fig. 3P outlines a suggested workflow for the benchmarking exercise with reference to existing tools and methods used in other sectors where appropriate. While not exhaustive, this should provide an understanding of the key steps and questions to be addressed.

WHAT	WHY	REFERENCE POINT	HOW (SUPPORTING TOOLS)
1 DISSECT EXISTING SOLUTIONS	To understand the system architectures of current solutions - that is, how their sub-assemblies and components are arranged and interact. <i>Note: consider undertaking this exercise for processes and relationships as well as products.</i>	With reference to past project deployments, what is the underlying system architecture for each reference solution?	Design Structure Matrices (DSM) can help to visualise system architecture (Fig.3Q) including sub-assemblies and constituent components, and how they relate to each other.
2 MEASURE COMPLEXITY	To assess the inherent complexity of each of the reference solutions. Complexity fuels direct and indirect costs and complexity in architecture is likely to be mirrored in the organisational and project complexity associated with implementation. This will provide an initial indication of the most suitable system architectures to consider or work from for the PP.	How complex is the system architecture for each reference solution in terms of number and type of, and interfaces between, components?	Complexity can be measured using a complexity factor (CF) developed by Boothroyd and Dewhurst $(N_p \times N_t \times N_i)^{1/3}$ Where N_p = number of parts; N_t = number of types of parts; N_i = the sum of the number of interfaces for each part.
3 UNDERSTAND NEEDS AND REQUIREMENTS	To understand, for each identified system architecture, the functions the components perform and how these relate to customer requirements. To develop a normalised (relative) measure of performance and cost for the components of each reference solution.	With reference to past project deployments, how does the system architecture of each reference solution address functions and requirements (and how well)?	Quality Function Deployment (QFD) can be used to understand how components are linked to functions and how these functions are linked to customer attributes (Fig.3Q).
4 ASSESS COMMONALITY	To understand the level of commonality in the sub-assemblies and components of each reference solution across its family of products. <i>Note: consider commonality in processes and relationships if possible.</i>	Which components of the system architecture were common across project specific deployments of each reference solution?	Total Constant Commonality Index (TCCI) or Commonality Index allows comparison of commonality between different product families, allowing comparison between different solutions - both existing and proposed. Degree of Commonality Index (DCI) may also be used, but is less useful than comparisons between product families.
5 IDENTIFY EXTERNAL DRIVERS FOR VARIETY	To help understand what is likely to drive variation in each of the reference solutions over time and the associated cost implications for redesign and assurance associated with changing requirements. This will identify the level of flexibility that would need to be built into the components of each reference solution.	How might future changes in requirements impact upon the design of components of each reference solution?	Generational Variety Index (GVI), in conjunction with QFD, can be used to identify those components most likely to require redesign in the future (Fig.3R).
6 ASSESS INTERNAL DRIVERS FOR VARIETY	To assess, for each reference solution, how coupled its constituent components are with respect to changes in specification. This will help to highlight those components which can most appropriately be combined into subassemblies.	With reference to past project deployments for each reference solution, how connected are components in terms of specification changes?	The Coupling Index (CI) can help to quantify connectivity and help understand the level of coupling within a design – helping identify internal drivers for change. The use of matrices to visualise CI is recommended (Fig.3S).
7 IDENTIFY ELEMENTS FOR REDESIGN	To identify, for the system architecture of each reference solution, where component redesign offers most benefit. This will support the development of candidate system architectures for the PP and areas of focus for ongoing development.	With reference to past project deployments for each reference solution, which aspects of the system architecture could be improved?	Generate a graph for each reference solution plotting each component according to the cost of providing variety. Divide the chart into quadrants as per (Fig.3T)to determine areas of focus for each system architecture. The use of commonality indices, variety indices (including GVI), and coupling indices provides a basis for challenging and improving system architectures (and potential PP architectures). Plotting components onto a graph (Fig.3U) of normalised commonality vs variety illustrates those candidates most suitable to be redesigned. Coupling Index (CI) helps to identify where this redesign is likely to necessitate the redesign of other, coupled components and hence inform the focus of any redesign of the architecture of the system.

Fig. 3P: Suggested benchmarking workflow

Note: this is an example of Quality Functional Deployment, the first toolset as part of CPQP.

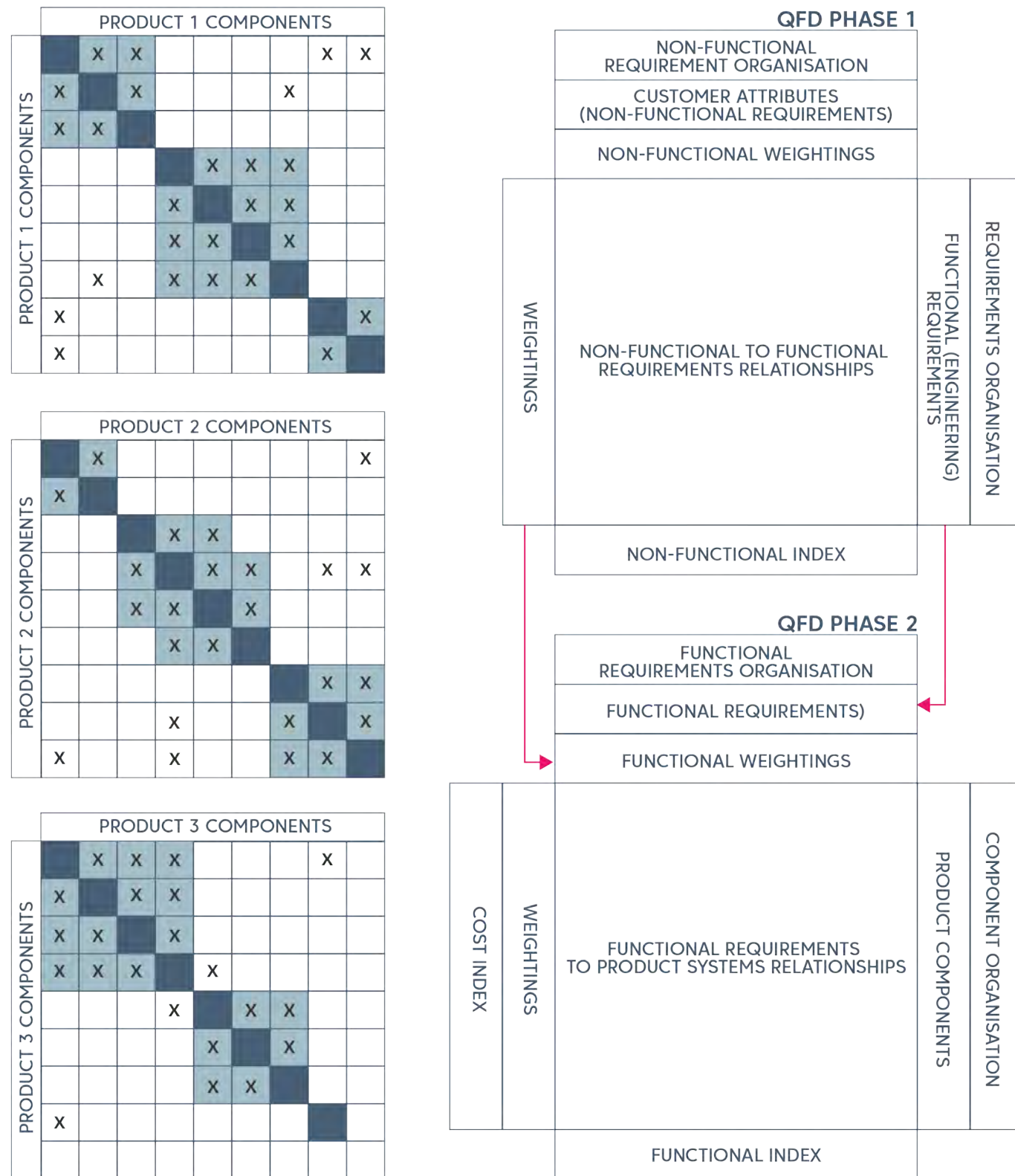

1. DISSECT EXISTING SOLUTIONS

To understand the system architectures of current solutions - that is, how their sub-assemblies and components are arranged and interact. Note: consider undertaking this exercise for processes and relationships as well as products. With reference to past project deployments, what is the underlying system architecture for each reference solution? Design Structure Matrices (DSM) can help to visualise system architecture (Fig.3Q) including sub-assemblies and constituent components, and how they relate to each other.

2. MEASURE COMPLEXITY

To assess the inherent complexity of each of the reference solutions. Complexity fuels direct and indirect costs and complexity in architecture is likely to be mirrored in the organisational and project complexity associated with implementation. This will provide an initial indication of the most suitable system architectures to consider or work from for the PP. How complex is the system architecture for each reference solution in terms of number and type of, and interfaces between, components? Complexity can be measured using a complexity factor (CF) developed by Boothroyd and Dewhurst.

$$(N_p \times N_t \times N_i)^{1/3}$$

Where N_p = number of parts;
 N_t = number of types of parts;
 N_i = the sum of the number of interfaces for each part.

3. UNDERSTAND NEEDS AND REQUIREMENTS

To understand, for each identified system architecture, the functions the components perform and how these relate to customer requirements. To develop a normalised (relative) measure of performance and cost for the components of each reference solution. With reference to past project deployments, how does the system architecture of each reference solution address functions and requirements (and how well)? Quality Function Deployment (QFD) can be used to understand how components are linked to functions and how these functions are linked to customer attributes (Fig.3Q).

Fig. 3Q: Design Structure Matrices and QFD for Mapping of components to functions and non-functional requirements (Customer Attributes)

4. ASSESS COMMONALITY

To understand the level of commonality in the sub-assemblies and components of each reference solution across its family of products.

Note: consider commonality in processes and relationships if possible. Which components of the system architecture were common across project specific deployments of each reference solution? Total Constant Commonality Index (TCCI) or Commonality Index allows comparison of commonality between different product families, allowing comparison between different solutions - both existing and proposed. Degree of Commonality Index (DCI) may also be used, but is less useful than comparisons between product families.

5. IDENTIFY EXTERNAL DRIVERS FOR VARIETY

To help understand what is likely to drive variation in each of the reference solutions over time and the associated cost implications for redesign and assurance associated with changing requirements. This will identify the level of flexibility that would need to be built into the components of each reference solution. How might future changes in requirements impact upon the design of components of each reference solution? Generational Variety Index (GVI), in conjunction with QFD, can be used to identify those components most likely to require redesign in the future (Fig.3R).

COMMONALITY: WHAT IS COMMON (OR NOT)?							GVI: WHAT SHOULD BE COMMON OR NOT?							
COMPONENT	ACROSS PROJECTS/APPLICATIONS				COMMONALITY SCORE	COMPONENT								
	# IN FAMILY	SAME DESIGN	SAME MATERIAL	SAME ASSEMBLY		A	B	C	D	E	F	G		
A	10	2	4	3	0.02		X	X						
B	8	4	4	2	0.06	X		X						X
C	4	4	4	2	0.49	X	X							
D	5	1	5	1	0.03					X	X	X		
E	2	2	2	2	1.00				X		X	X		
F	8	2	8	8	0.25				X	X			X	
G	3	3	3	3	1.00		X		X	X	X			
TOTAL # COMPONENTS	40			PCI	24%	DSM: HOW COMPONENTS ARE CONNECTED (OR NOT)								
						CI: QUANTIFIES CONNECTIONS AND MAPS DEPENDENCIES								

CHANGE LIKELIHOOD

Fig. 3R: How commonality, variety and interfaces can be visualised

6. ASSESS INTERNAL DRIVERS FOR VARIETY

To assess, for each reference solution, how coupled its constituent components are with respect to changes in specification. This will help to highlight those components which can most appropriately be combined into subassemblies. With reference to past project deployments for each reference solution, how connected are components in terms of specification changes? The Coupling Index (CI) can help to quantify connectivity and help understand the level of coupling within a design – helping identify internal drivers for change. The use of matrices to visualise CI is recommended (Fig.3S).

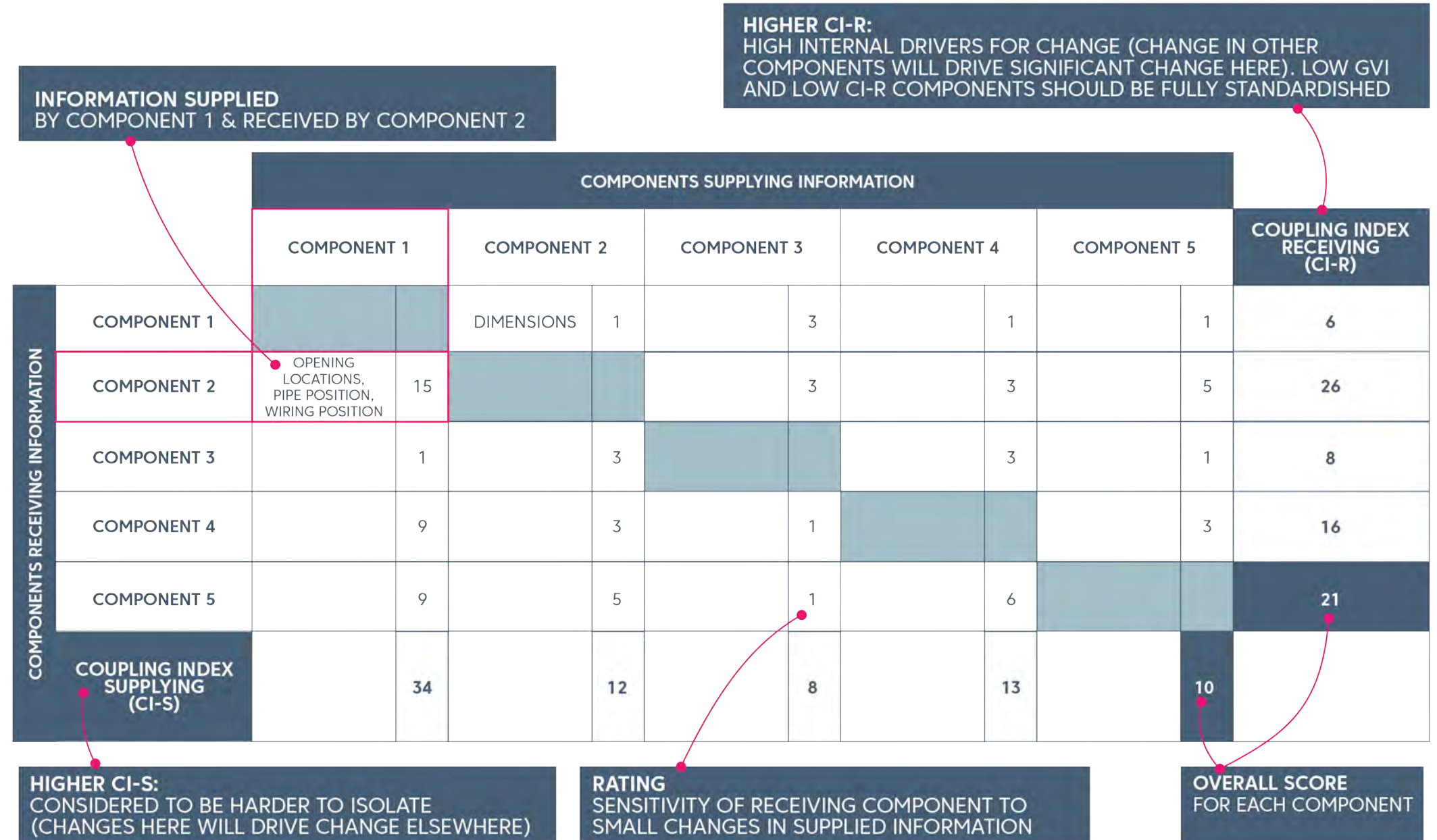

Fig. 3S: Hypothetical Coupling Index Matrix

7. IDENTIFY ELEMENTS FOR REDESIGN

To identify, for the system architecture of each reference solution, where component redesign offers most benefit. This will support the development of candidate system architectures for the PP and areas of focus for ongoing development. With reference to past project deployments for each reference solution, which aspects of the system architecture could be improved. Generate a graph for each reference solution plotting each component according to the cost of providing variety. Divide the chart into quadrants as per (Fig.3T) to determine areas of focus for each system architecture. The use of commonality indices, variety indices (including GVI), and coupling indices provides a basis for challenging and improving system architectures (and potential PP architectures). Plotting components onto a graph (Fig.3U) of normalised commonality vs variety illustrates those candidates most suitable to be redesigned. Coupling Index (CI) helps to identify where this redesign is likely to necessitate the redesign of other, coupled components and hence inform the focus of any redesign of the architecture of the system.

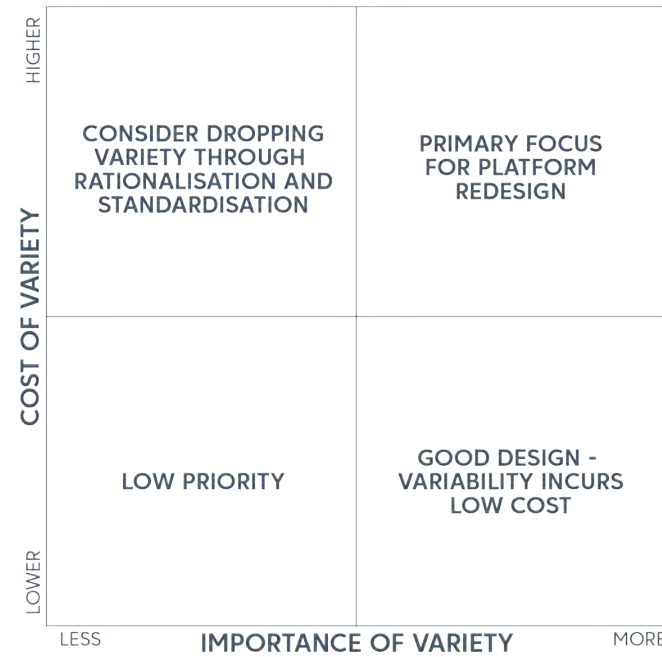

Fig. 3T: Identifying areas of focus using cost and importance of variety

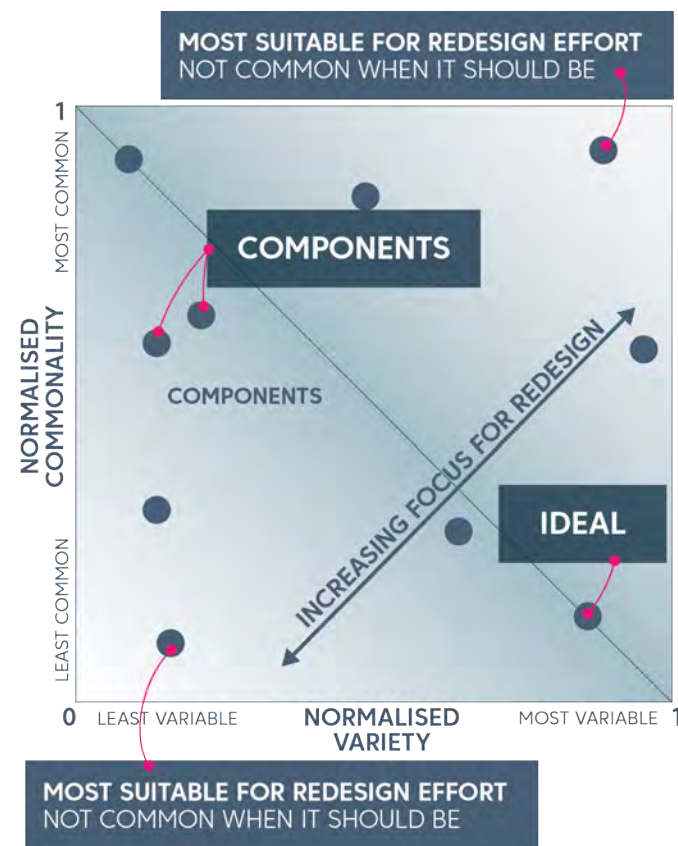

Fig. 3U: Identifying areas of focus using commonality and variety

2 PRODUCT PLATFORM PLANNING | GENERATE CONCEPT(S)

GENERATE CONCEPT(S)

Based on benchmarking and areas needing redesign (or design), generate 'candidate' architectures as alternatives to existing architectures, which can be assessed using the same tools and processes set out in 'benchmarking' above to ensure against the same metrics for improvement. The benchmarking process highlights the areas where changes are likely to be most beneficial – for example by changing the functions which elements perform or the way they interface.

A useful place to start with this is reviewing the Design Structure Matrix to explore how to isolate key components which are likely to change frequently in the target segments by reducing interfaces and combining components into sub-assemblies. With new architectures, the benchmarking process can be repeated to identify whether performance has been improved or whether there are new areas requiring redesign.

To avoid getting stuck in too much detail at this stage, it can be beneficial to test changes to see if they are an architectural decision (and hence a focus at this stage) and deprioritise decisions which are not. Architectural decisions are those which have a significant impact on performance, trade-offs and ultimately cost, as well as affecting the ability to customise the design. Examples might include whether internal walls are load-bearing and contribute to stability of a volumetric frame, or whether services within a panelised wall system are integrated or not.

This can be done by asking two questions:

- 1. Sensitivity:** does this decision strongly influence key metrics (such as performance, cost and risk)? GVI helps here.
- 2. Connectivity:** would substantial rework be required to change this decision? Could we make this decision downstream without regards for other decisions? DSM and CI helps here.

Using the answers to these two questions, we can consider a 2x2 matrix (Fig. 3V), which allows us to prioritise. Sensitive and highly connected decisions are architectural decisions and should be prioritised. Those which are neither sensitive nor connected can be given the lowest priority at this stage.

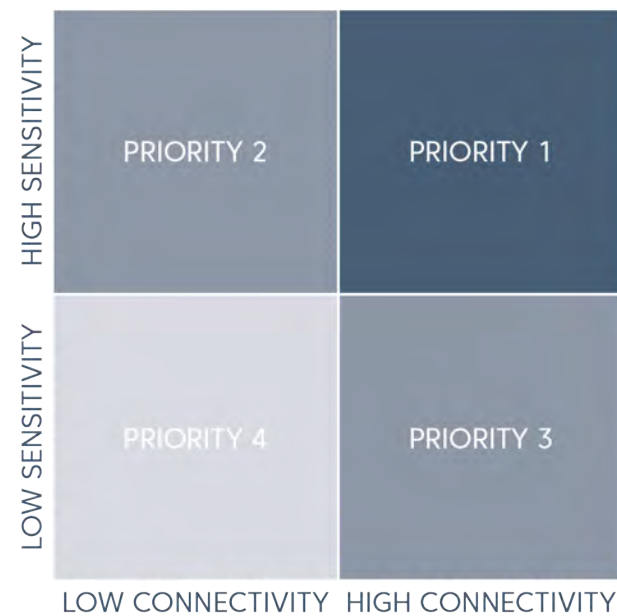

Fig. 3V: Mapping sensitivity and connectivity

DEVELOP COMMONALITY PLAN

Building on the outline commonality strategy developed as part of the PP strategy, the Product Platform Provider can now develop a detailed commonality plan for the preferred concept(s). This plan sets out in more detail how the commonality strategy will be achieved and explicitly accounts for the approximate costs associated with development and production of each product. As with the strategy, this needs to consider four dimensions of technical, organisational, financial, and market acceptability.

Technical: Which elements are common, at which hierarchy levels and how many variants of those components will be needed to deliver the necessary variety? How many production steps can be common and how might they vary?

Hierarchy levels: features → components → sub-assemblies → product.

Organisational: Which elements are 'softer' and rely on the skills, knowledge and experience contained within the organisation? Determine where and how this may present additional costs or barriers to commonality.

Financial: Determine the investment needed to develop commonality and assess the financial benefit in greater detail (noting the emerging tension between DfA (designing for assembly: focusing on reducing part count and ease of assembly) and DfM (designing for manufacture: focusing on simplifying components and ease of production)) and the potential downstream costs and benefits of commonality, based on the interfaces with other systems and touchpoints identified above.

Market acceptability: Identify and map common elements and variants to product variants corresponding with particular segments (or projects where known). Determine acceptability to the market in terms of achieving necessary variety. Review and update roadmap and planning horizon as appropriate.

DETERMINE VARIANTS

Based on the commonality plan and the preferred architecture, update the mapping of requirements to the components. Identify variability in requirements (as per GVI assessments).

This represents the extent to which variations are meaningful to customers, and should include target values. This is driven primarily by what customers in the market value.

For repeatable elements to meet a range of performance targets, a range of those elements will be over-performing (i.e. will be exceeding performance targets). This is acceptable if the over-performance is more than compensated by consolidating the number of elements.

You will need to:

- **Define over-performance (physical, process, etc.) for sub-assemblies and associated processes, knowledge and people** – including considering the implications/burden of over-performance in these areas. Using the insight from the cause-effect relationships analysed as part of the commonality strategy may help here.
- **Estimate the costs and benefits of rationalising the number of component variants** (benefits = simplification and repetition; costs = over-performance and reduced choice). Consider how assurance regimes affect costs across a product family and the implications for the current approach – compare the cost of over-performance (e.g. cost difference between different assurance regimes) and the benefits (e.g. single approval across multiple segments).
- **Determine optimal number of variants, identifying where degrees of freedom can be given ‘room to grow’** (i.e. by adding capacity, space or redundancy), enabling easier changes and enhancements in the future. In particular, consider where flexibility in the development and selection of interfaces between modules can be included, since it will likely add significant value and robustness to the platform. However, this is a balance as excessive flexibility will increase engineering and manufacturing costs.

DEVELOP PLATFORM PERFORMANCE SPECIFICATION

Having defined the number of variants and their performance, this should be clearly documented in a platform performance specification.

PRODUCT PLATFORM PERFORMANCE SPECIFICATION

- **Critical forms, functions and features** will become design drivers that will be utilised in the design section. Other factors are subordinated to these in a series of trade-offs.
- **Cost and performance targets** for modules of the chosen product family architecture should also be clearly documented.
- **Roles, responsibilities and authorities** should be set out, particularly relating to changing targets.

3 PRODUCT PLATFORM DESIGN | INTRODUCTION

PRODUCT PLATFORM DESIGN

PREREQUISITES

Before proceeding to product platform design, Product Platform Providers should first reflect on the completed product platform plan, ensuring they have a clear and collective understanding of the following:

- The information management systems that will be required for the platform
- Performance benchmarks for previous and/or competitors' products
- Key areas of commonality and difference required to deliver the strategy
- The brief for design and production, including target performance levels and requirements

With strategy and planning completed, you can now proceed to the design stage. This consists not only of designing the product platform itself (including the kit of parts and interfaces) but also designing the production and assembly processes and the assurance regime required to deliver effectively. The main output from this stage will be a deployment manual for those using the platform in project delivery.

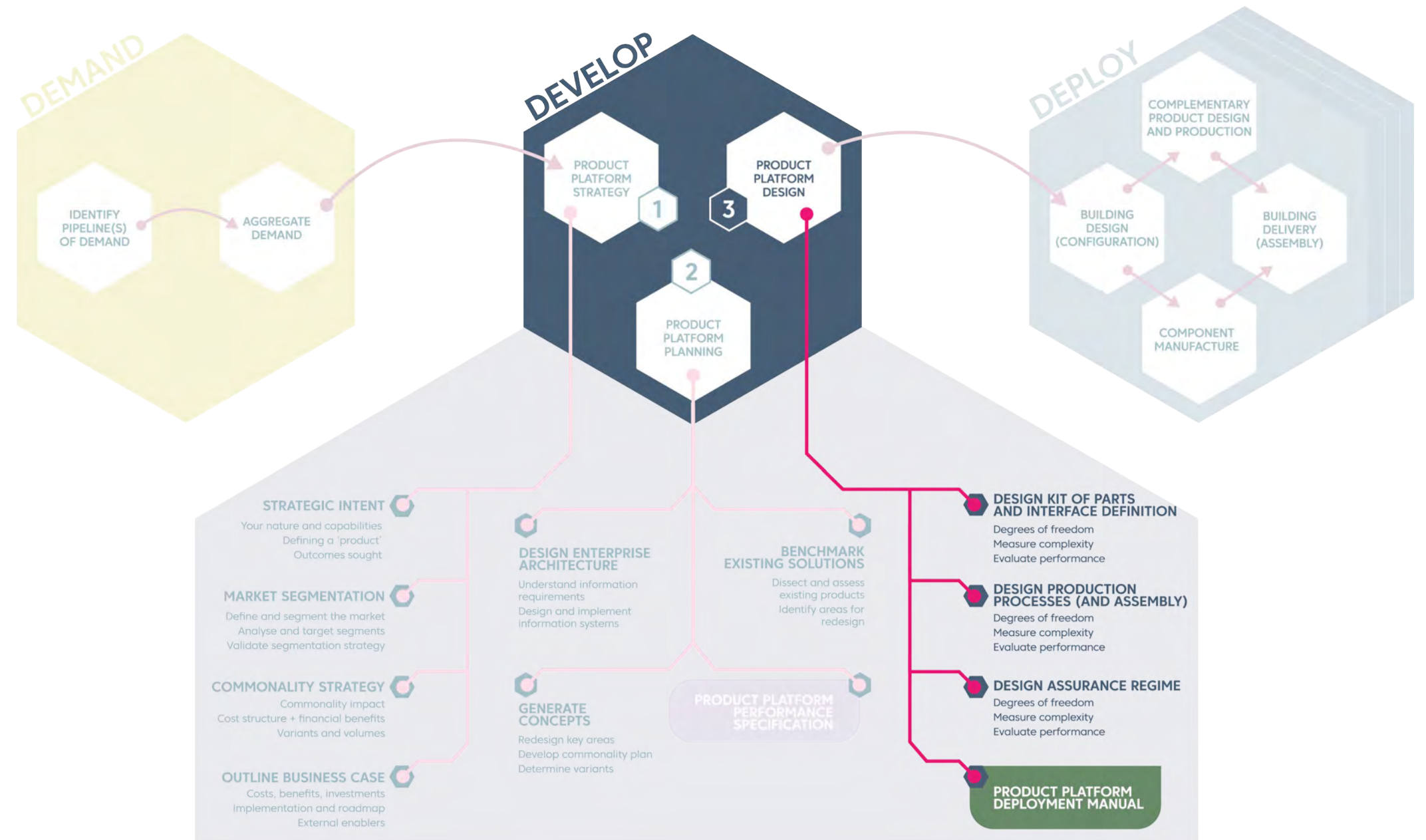

Fig. 3W: Product Platform Design

DESIGN KIT OF PARTS AND INTERFACE DEFINITION

In order to set interface definitions, the creation of initial assembly flow charts for offsite and onsite processes can be utilised to map the interfaces that need to be defined. Interfaces can then be defined functionally and physically for further development in the design process. Initial drawings/schematics can then be created to describe the product and its interfaces, complemented with a bill of materials (a list of items that create the product).

DEGREES OF FREEDOM

Degrees of freedom in this context describe modifications in the design that allow the possibility of upgrades or changes in the future, without a complete redesign.

In order to understand what degrees of freedom to build in, the Product Platform Roadmap should be studied to determine how the product should be changed over time to suit the market needs. Any potential degrees of freedom should be identified and assessed for design trade-offs using the product team's knowledge to compare short term gains vs long term gains. Degrees of freedom should then be incorporated into the design if benefits are verified.

MEASURE COMPLEXITY (ASSEMBLY)

The creation of assembly flow charts for offsite and onsite processes are required to assess the complexity of an assembly. Once this has been undertaken, measurement of the complexity can be undertaken using a method such as the Lucas method. Fig. 3X is an example of measuring the part count efficiency of an assembly.

EVALUATE PERFORMANCE AND COST

The evaluation of the performance and cost can be set up at this point for reviews throughout this process to understand the benefits of the improvements made. An evaluation could be undertaken using a verification model such as a cost modelling or computer aided design modelling with finite element analysis.



Note: This is an example of a *Design for Manufacture and Assembly* tool, the third Toolset as part of CPQP.

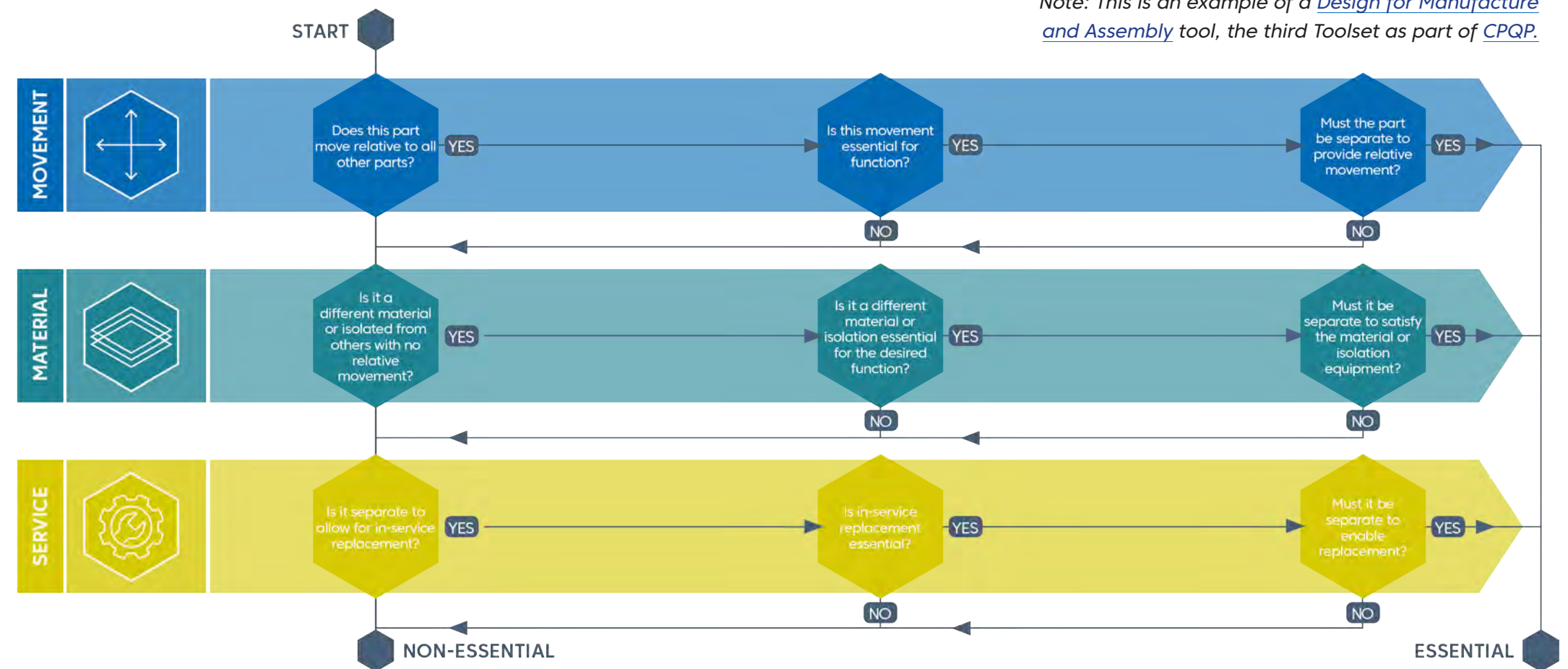

Fig. 3X: Example of measuring the part count efficiency of an assembly

Source: Swift, K. G. & Booker, J. D. (2003). *Process selection: From design to manufacture* (2nd ed.). Oxford, UK: Butterworth-Heinemann.

3 PRODUCT PLATFORM DESIGN | DESIGN PRODUCTION PROCESSES AND ASSEMBLY

DESIGN PRODUCTION PROCESS (AND ASSEMBLY)

In order to design the production process, the bill of materials should be used to identify the products that will be made in-house and not outsourced. If products are being made in-house, the process flow chart, process instructions and other documentation should be completed to design the process.

BUILD IN DEGREES OF FREEDOM (PRODUCTION)

In order to understand what degrees of freedom to build in, the Product Platform Roadmap should be studied to determine how the product will change over time to suit the market needs. Any potential degrees of freedom should be identified and assessed for production cost using the production team's knowledge to compare short term gains vs long term gains. Degrees of freedom should then be incorporated into the design if benefits are verified.

MEASURE COMPLEXITY (PRODUCTION)

The creation of production flow charts for offsite and onsite processes are required to assess the complexity of the production processes. Once this has been undertaken, measurement of the complexity can be undertaken using a method such as the Lucas method. Fig. 3Y is an example of classifying the complexity of a product to determine the complexity of its process.

Further guidance on DfMA will soon be available from the Hub and this section will be updated accordingly. Once complete any modifications to simplify the production complexity can be captured and discussed with the relevant stakeholders.

EVALUATE PERFORMANCE AND COST

The evaluation process has been included on page 44, 'Evaluate Performance and Cost'. This can be revisited to ensure performance and cost are on plan.



SHAPE	COMPLEXITY		DETAILS	
 CYLINDRICAL PART ENVELOPE (SOLID OF REVOLUTION)	SINGLE AXIS	A1	Basic rotational features only	Rotational symmetry, grooves, undercuts, steps, chamfers, tapers and holes along the primary axis or centre lines.
		A2	Regular/secondary repetitive features	Internal/external threads, knurling and simple contours through flats, splines, keyways on or around the primary axis or centre lines.
	SECONDARY AXIS	A3	Internal	Holes, threads, counter-bores and other internal features not on the primary axis.
		A4	Internal or external features	Projections, complex features, blind flats, splines, keyways on secondary axis.
	COMPLEX	A5	Irregular or complex forms	Complex contoured surfaces and/or series of features that are not represented in previous categories.
 RECTANGULAR/ CUBIC PRISM PART ENVELOPE	SINGLE AXIS OR PLANE	B1	Basic Features Only	Through steps, chamfers and grooves, channels, slots and holes, threads on a single axis.
		B2	Regular/secondary repetitive features	Regular through features, T-slots and racks, plain gear sections etc. repetitive holes, threads, counter-bores on a single plane.
	MULTIPLE AXIS	B3	Orthogonal/straight line based features	Regular orthogonal or straight line based pockets, projections on one or more axis, angled holes, threads and counter-bores.
		B4	Simple curved features on a single plane	Curves in internal or external surfaces.
	COMPLEX	B5	Irregular and/or contoured forms	Complex 3D contoured surfaces, geometries that cannot be assigned to previous categories.
 FLAT OR THIN-WALLED SECTION COMPONENTS	SINGLE AXIS	C1	Basic Features Only	Blanks, washers, simple bends, forms and through features on or parallel to primary axis.
	SECONDARY OR REPETITIVE FEATURES	C2	Uniform section or wall thickness	Plain cogs and gears, multiple or continuous bends and forms.
		C3	Non-Uniform section or wall thickness	Section changes not made up of multiple bends or forms, steps, tapers and blind features.
	REGULAR FORMS	C4	Cup, Cone and box type parts	Components may involve changes in section thickness.
	COMPLEX	C5	Non-Uniform and/or contoured parts	Complex or irregular features or series of features which are not represented in previous categories.

Fig. 3Y: Example of classifying the complexity of a product to determine the complexity of its process

DESIGN ASSURANCE REGIME

In order to assure the product conforms to the design specification, an assurance regime should be set up to check the product. Using the process flow chart from Fig. 3X, an output from each step should be determined and a verification method should be selected. This could be a measurement check or a visual inspection and should be recorded using formal documentation.

BUILD IN DEGREES OF FREEDOM (ASSURANCE)

In order to understand what degrees of freedom to build in, the Product Platform Roadmap should be studied to determine whether assurance testing should verify at a performance standard that ensures the product can be used on future projects with increased performance requirements. The long-term gains of this should be assessed from a cost perspective against the short-term gains.

DEVELOP PRODUCT PLATFORM SPECIFICATION

The information that has been generated in the design of the product should be captured in a specification document, this will include:

- Assembly flow charts
- Production flow charts and instructions
- Interface specification
- Drawings/schematics
- Bill of materials
- Efficiency of assembly measurement
- Efficiency of production measurement
- Assurance regime for production



Note: as the maturity of design increases from concept to detail design during the Develop phase, [Design Failure Mode and Effects Analysis](#) and [Process Failure Mode and Effects Analysis](#) guidelines

should be used as part of risk evaluation. [CPQP](#) outlines these tools and can be found via the embedded links and in Section 6, Best Practice.



3 PRODUCT PLATFORM DESIGN | PRODUCT PLATFORM DEPLOYMENT MANUAL

DEVELOP DEPLOYMENT MANUAL

The Deployment Manual sets out the information that Product Platform Providers need to provide to the project design teams to enable Product Platform deployment.

A directory of information will be created for Product Platform Providers to create a Deployment Manual. This will be used by project teams, so PPs can be used on their projects. The steps shown in Fig. 3Z have been mapped to the RIBA DfMA workstages.

OUTPUTS TO PROJECT DOMAIN ("DEPLOY")



Having completed the steps above, the product platform provider is now able to provide the following to those operating in the project domain:

- **core repeatable elements** that have been designed to meet the majority of client requirements in one or more defined market segments;
- **a variety of peripheral components** that are available to be configured for different applications, that interact with the core assets via stable defined interfaces;
- **specification information** for the products above, showing that they meet defined quality standards;
- **a deployment manual** for assembling, using and configuring all components of the platform;
- assurance that the products on the platform will be able to be adapted to meet evolving needs in future (as evidenced by the Product Platform Roadmap).

Fig. 3Z: Deployment manual development aligned to RIBA DfMA workstages

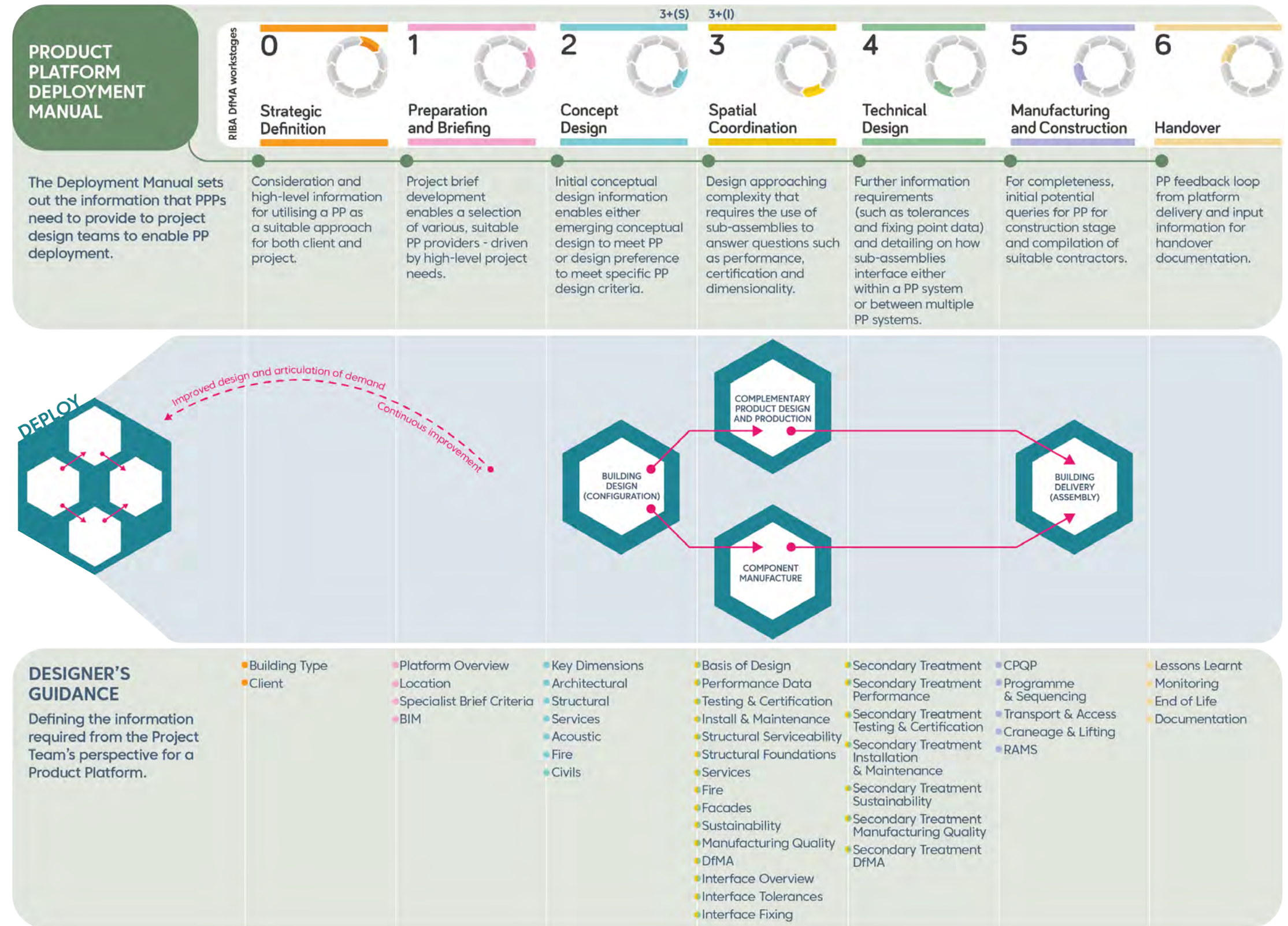

DEPLOY: DETERMINING VALUE

Project teams may need to assess different platform systems against a range of other options as part of a project's design and development. Accessing this information from platform providers or directly from a deployment manual will improve speed of delivery. The platforms can be directly compared against the value profile provided by the client.

The work the Hub has done has identified deployment manuals as playing a key role in developing product platforms.

Completion of a deployment manual is a fundamental for Principle 7 (**Structured Information**) and ensures adherence to the other rules among potential project teams.

As the importance of deployment manuals has grown, the Hub has worked with industrial partners to complete draft, example deployment manuals as well as guidance from the Project Design Team's perspective.

Bryden Wood is developing a deployment manual for Platform II.

The SEISMIC Group is developing various levels of structured information for various audiences, such as potential customers, and technical information for project design teams.

Further development is ongoing to progress the deployment manuals and guidance as an industry-accepted document.

Publishable deployment manuals and deployment manual guidance shall be available via the [Hub website](#).

4. RECOMMENDATIONS



4.1. Recommendations

The purpose of this Rulebook is to **educate**, **enable** and **empower** by establishing rules and parameters that, through voluntary consensus, support consistent development and deployment of product platforms that deliver better economic, social and environmental outcomes.

Our recommendations and next steps are intended to reinforce this ambition, encouraging industry to develop platforms that make use of the Rules, Principles and guidance that this book sets out; enabling government, client organisations, and standards bodies to play a positive role in this transition and supplying further information and detail which empower all parties to move forward with confidence.

	WHAT	HOW	WHO
EDUCATE	Continued development of the Rulebook	Establish Legacy model that supports continued development of the Rulebook (see Section 5, Legacy).	The Hub, Infrastructure Projects Authority and Construction Leadership Council
		Continued engagement, feedback and improvement of Rulebook (inc alignment with parallel initiatives such as Construction Productivity Taskforce)	Rulebook Custodian plus Academic & Industry Users including Representative Bodies (e.g. CLC, RIBA, ICE, CIOB, etc.)
		Create supporting guidance that is explicit in the methodology for aggregating demand (over and above ‘Defining the Need’ report).	The Hub
		Create guidance focussed towards the economic and organisation changes required by industry actors, to realise commercially viable adoption of product platforms.	The Hub
	Case Studies	Development of Product Platform Deployment Manual(s) to support key market segments	The Hub & Industry Partners
ENABLE	Training	Expansion of industry case studies that demonstrate practical application of platforms, identifying points of learning	The Hub & Industry Partners
	Embed Rules and Principles	Develop training materials that communicate the key principles of the Rulebook and its real-world application.	Rulebook Owner (within input from Product Platform Providers)
		Cabinet Office and Infrastructure Projects Authority to reference the Rulebook in working groups, supporting documentation and guidance published in response to the Construction Playbook and TIP Roadmap. Independent review of future pipeline to determine opportunity for commonality and harmonisation	Government
	Establish structured information for products, production and organisations	Align and link the Rulebook, the Code for Construction Product Information and Lexicon, to drive higher standards in the presentation of construction product information and assurance.	The Hub/CCPI
		Work with NRM, Uniclass et al to develop and mature a system hierarchy that informs a universal classification of building elements. Develop a classification system for interfaces.	Product Platform Providers and Manufacturers Product Platform Providers and Manufacturers
Implementation Support	Active engagement with, and support to, departmental clients implementing Rulebook during FY 21/22	The Hub	
EMPOWER	Develop Product Platform Maturity Assessment	Create a Product Platform Maturity Assessment, aligned to the Rulebook, aiding the measurement of product platform maturity and informing forward steps with regard to: 1. Demand: Clients and Product Platform Provider’s ability to assess demand 2. Develop: The development of product platforms, by Product Platform Providers 3. Deploy: The application of PPs at a project or programmatic level	Rulebook Owner
	Harmonisation of Demand and Requirements	To take forward recommendations within both Defining the Need report and The Specification Maturity Roadmap , to harmonise, digitise and rationalise specifications (both in form and content) within and across Government departments, consistent with the Construction Playbook.	Government Departments / Infrastructure Projects Authority
		PP Maturity Assessment	Identification of leading product platform expertise, within industry, competent to apply Product Platform Maturity Assessment Application of the Product Platform Maturity Assessment to assess the maturity of existing or developing product platforms.

5. LEGACY

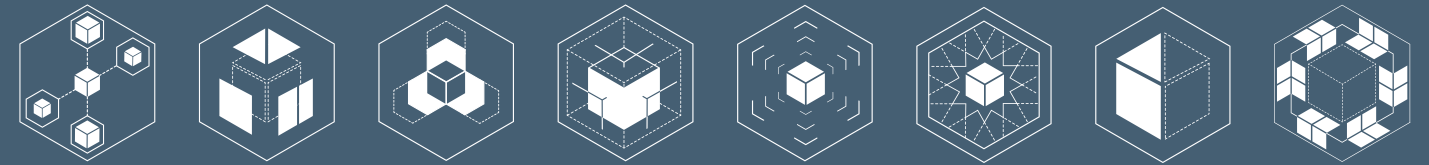

5.1. Legacy principles

RULEBOOK LEGACY

It is critical that measures are put in place to ensure the Rulebook remains a live asset. Whilst this first edition provides a baseline and guidance on direction, it is intended to evolve and develop to support practical application and adoption of product platforms in construction. This section outlines the principles that will underpin the development of a legacy strategy to deliver this ambition.

KEY PRINCIPLES AND EXPECTATIONS

The Rulebook is intended to be **Open, Collaborative and Continuously Improving**.

These principles will not be achieved organically; instead formal structure is required to facilitate the sharing of ideas, information and learning that accelerates understanding and adoption.

As the Hub moves to close its programme, it has committed to working alongside the government to shape the future governance model that will uphold these principles.

DEFINING KEY ROLES

As part of the future governance model for the Rulebook, we anticipate three key roles will be required:

1. OWNERS: Setting the direction, strategy and rules of engagement with broader stakeholders. This is expected to be a dual responsibility, with Government defining policy and visibility of aggregated pipeline, whilst industry deliver compliant implementation and continuous improvement.

2. CUSTODIANS: Acting impartially and independently, the custodians will be required to establish mechanisms that gather, analyse and implement feedback into future editions of the Rulebook.

3. USERS: Testing the application of the Rulebook and providing feedback. This is expected to include:

- **Clients:** verifying their ability to comply with a potential platform mandate and to develop aggregated demand
- **Product Platform Providers:** developing product platforms in accordance with the Rules.
- **Design teams:** learning how the deployment of product platforms affect their ways of working at a project and programmatic level.
- **Manufacturers/suppliers:** recognise and facilitate their interfacing with product platforms.

During consultation on the contents of the Rulebook there was extensive debate surrounding the need for these and additional roles. This has highlighted the importance of shaping the governance structure in seeking to embed the development and application of the Rulebook, as part of a considered legacy strategy.

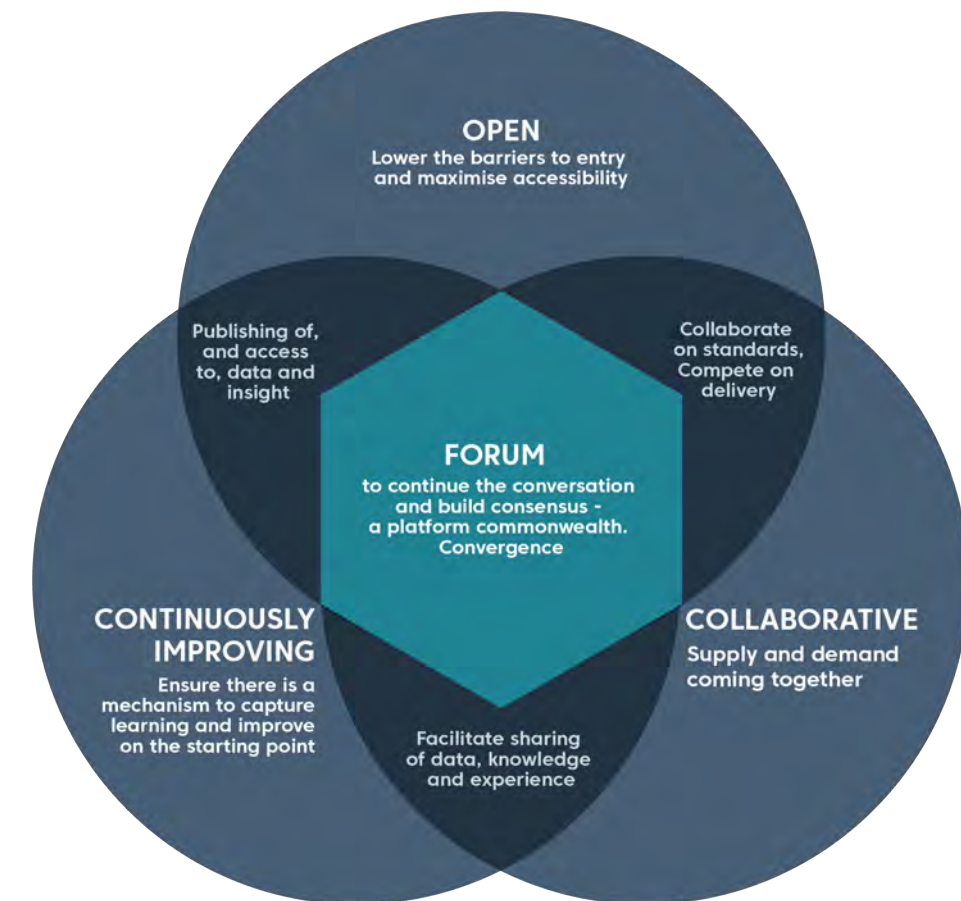
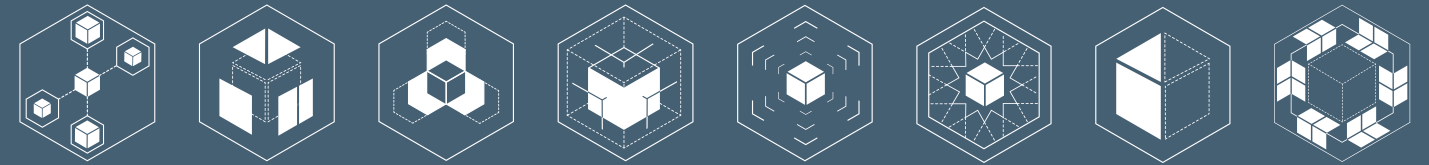

Fig. 5A: Venn diagram demonstrating key principles and their interaction

OPEN	COLLABORATIVE	CONTINUOUSLY IMPROVING
The Rulebook is intended to provide a common and open basis for the exploration and development of product platforms, lowering barriers to entry and improving accessibility.	For product platforms to succeed, all parties involved in research, supply and demand will need to continue to collaborate on standards whilst maintaining competition on delivery.	The Rulebook is not a finished, static artefact. It is intended to continue to evolve through feedback and learning from practical applications, requiring a managed mechanism for a continuous cycle of learning, development and improvement that also supports progressive data-driven harmonisation.

6. BEST PRACTICE



6.1. Case studies

This section contains a selection of leading examples where organisations have successfully developed and deployed Product Platforms. Within each case study, we identify the Rules that apply – identified by the icons to the right – and highlight areas in which the approach adopted aligns with earlier guidance.

For the SEISMIC case study, we have specifically mapped the application of the 8 rules to provide you, as the reader, with a real world illustration of all rules. As part of next step plans, we look towards developing this further with our exemplar case studies.

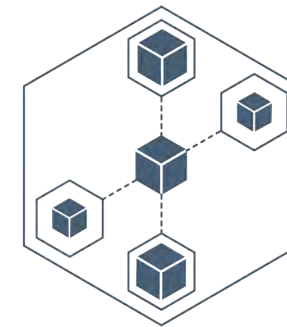

1. DEPLOYABLE

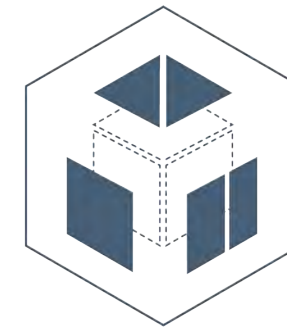

2. CONFIGURABLE



3. COMMON REPEATABLE ELEMENTS

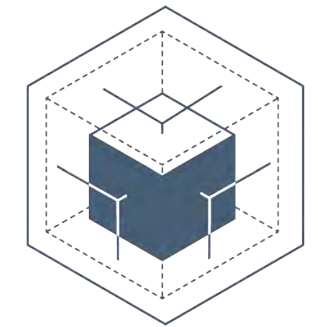

4. INTERFACES

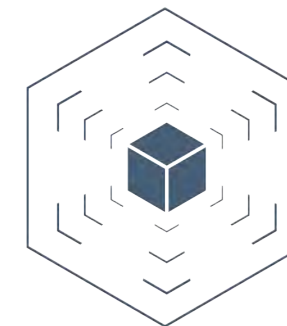

5. OPEN

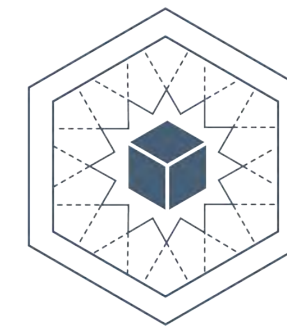

6. QUALITY

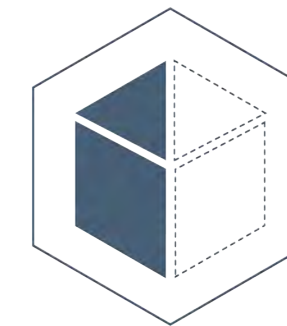

7. STRUCTURED INFORMATION

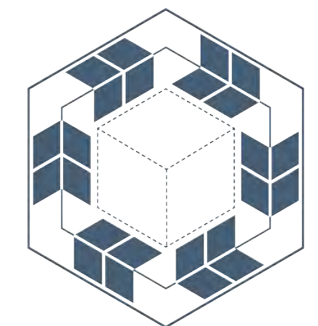

8. CIRCULAR

6.1.1 CASE STUDY | The Seismic Platform

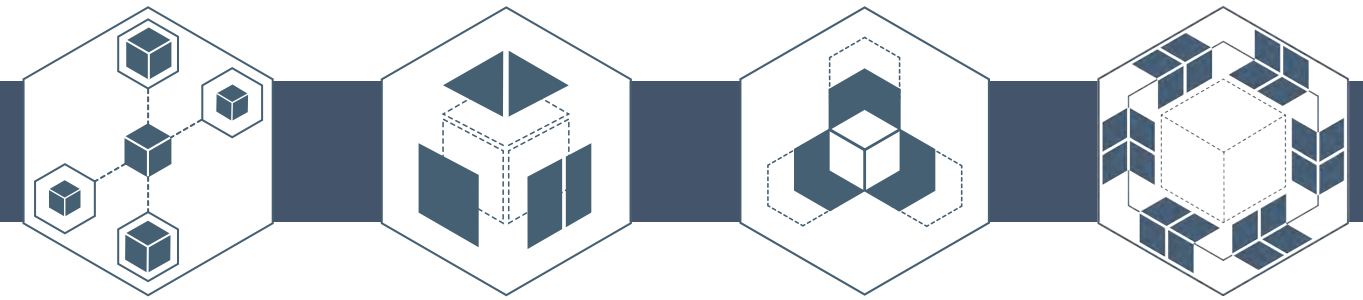

CASE STUDY: THE SEISMIC PLATFORM

The Seismic II collaboration comprises of industry partners the Seismic Group, Algeco (formerly Elliott UK), McAvoy Group, Tata Steel UK and academic partners Manufacturing Technology Centre, National Composite Centre and SPECIFIC Swansea University. In 2017, Seismic I developed a revolutionary universal corner connector, which enhanced horizontal and vertical interconnectivity of structural modular systems.

Seismic II builds upon this work and componentises and standardises the floor, ceiling, roof, internal wall and building envelope systems that integrate simply with the Seismic frame. The frame is scalable according to requirements using module spans of 8m and 10m and currently has two fully tested component specifications: Option 1 and Option 2. Both options can be **configurable** for MMC Category 1 - Pre-manufactured 3D primary structural systems or MMC Category 2 - Pre-manufactured 2D primary structural systems, depending on client requirements. The universal corner connector means that these modular buildings can be reconfigured and relocated depending on the changing need for flexibility, and it is even possible to restructure a building. By having this incorporated into the design, it enhances the scope of sustainability and extension of service life for these modules.

Seismic Option 1 and Option 2 Sub-Assembly configurations have been tested extensively for structural, fire, vibration and acoustic performance and both configurations are fully pre-assured and independently verified.

The Seismic II Product Platform Construction System was launched in March 2022 and is suitable to be **deployed** in a range of different sectors, including schools, hospitals, offices and apartments, subject to sector specific component specifications. Clients or suppliers can develop and add their own specification of components beyond Option 1 and 2 to suit their requirements and meet with changing regulations. The platform is market ready and currently accessible to anyone via the Seismic Group, McAvoy or Algeco with the intention that it will be freely marketed subject to volume demand. The platform has been independently assessed by the academic partners to achieve 70% less carbon, 70% faster assembly and 47% better value than traditional construction.

INTEGRATED DELIVERY Model

(see p30): The Seismic Platform uses an integrated delivery model.

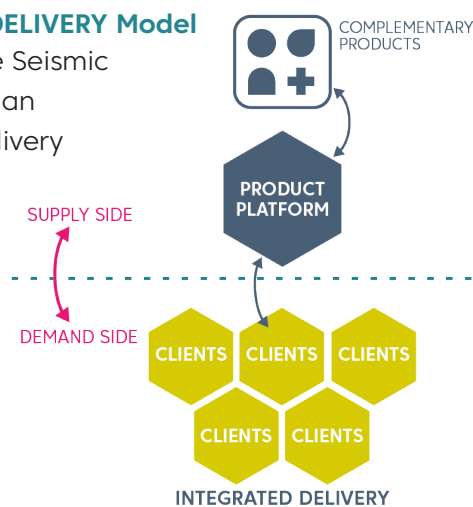

OUTPUT Model

(see p30): Tata Steel UK use an output model to deliver their products to a number of different product platform providers.

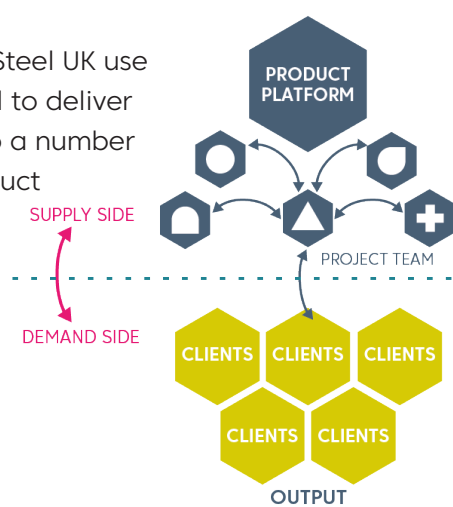

PLATFORM RULES AND APPROACH

Reconfigurability: modules have a long service life as they can be reconfigured using the universal connector

Modularity: Can be deployed as 2D or 3D Pre-manufactured primary structural systems

Offsite manufacture: High % Pre-manufactured Value (PMV). Delivery and assembly of the configurable components is predictable and reliable, and minimal construction processes are required on site

Circular: The Seismic Platform enables disassembly and re-use of component parts and sub-assemblies beyond first intended deployment



[>>CLICK HERE to learn more about the Seismic Platform](#)

PRODUCT PLATFORM RULES AND PRINCIPLES APPLIED

As a demonstration of the Rules and Principles in their real-world application, we have plotted the SEISMIC product platform against them below, highlighting the development of the SEISMIC platform in working towards these.









THE HUB'S PRODUCT PLATFORM RULES	SEISMIC PLATFORM EXAMPLE	NEXT STEPS/IN DEVELOPMENT
 1. DEPLOYABLE	Schools, hospitals, offices, and apartments.	
 2. CONFIGURABLE	Clients or suppliers can develop and add their own specification of components to suit their requirements and meet with changing regulations.	Option 3, 4, 5, etc.
 3. REPEATABLE	Repeatable components and SA. Repeatable relationships. Repeatable knowledge.	Repeatable off-site volume manufacturing process.
 4. DEFINED INTERFACES	Frame and connector.	
 5. OPEN	Project teams are able to gain access to structured information for the components, including the design data for the connector/frame and cassettes, in order to deploy the Seismic Platform.	
 6. QUALITY STANDARD	Product performance: fire; acoustic; structural; vibration.	Off-site factory quality management system.
 7. STRUCTURED INFORMATION	Seismic II Level 2 Report - Option 1	Final release of SEISMIC II Level 1, 2, and 3 report specifications.
 8. CIRCULAR	The Seismic Platform enables disassembly and re-use of component parts and sub-assemblies, beyond first intended deployment. LCA conducted.	Guidance on re-deployment

Fig. 6A: Application of the Product Platform Rules and Principles to Seismic II

6.1.2 CASE STUDY | Platform II



CASE STUDY: PLATFORM II

Originally developed for the Ministry of Justice (MOJ) as part of the Prison Estate Transformation Programme, Bryden Wood's Platform II is a versatile, midspan (~8m), low carbon structural system. Specifically designed to be configurable for multiple building typologies across the government estate, it has been applied in sectors such as healthcare, education and residential.

With a focus toward being a system that is highly repeatable and with a low barrier to entry for supply chains to support delivery at scale, Platform II has been developed with design for manufacture and assembly at its core.

A digital library of the components (e.g. columns, beams, concrete slabs, and temporary works) contains product information data such as maximum spans and tolerances, as well as method statements for manufacture and installation. Through the use of complementary technologies, such as the generative design PRISM app, Platform II can be rapidly configured in alternative layouts within minutes, including simulation and feedback on performance criteria such as energy balance and accessibility.

With a digital manufacturing workflow, key components have designed for automated production; with robotic cuts and welding (a UK first to receive UKCA and BSI accreditation) components within Platform II can be manufactured to millimetre accuracy. With a repeatable assembly process that incorporates automation on site as well, Platform II has been designed to limit reliance upon specialist skills, reduce operative numbers and increase productivity.

[>>CLICK HERE to learn more about Platform II](#)

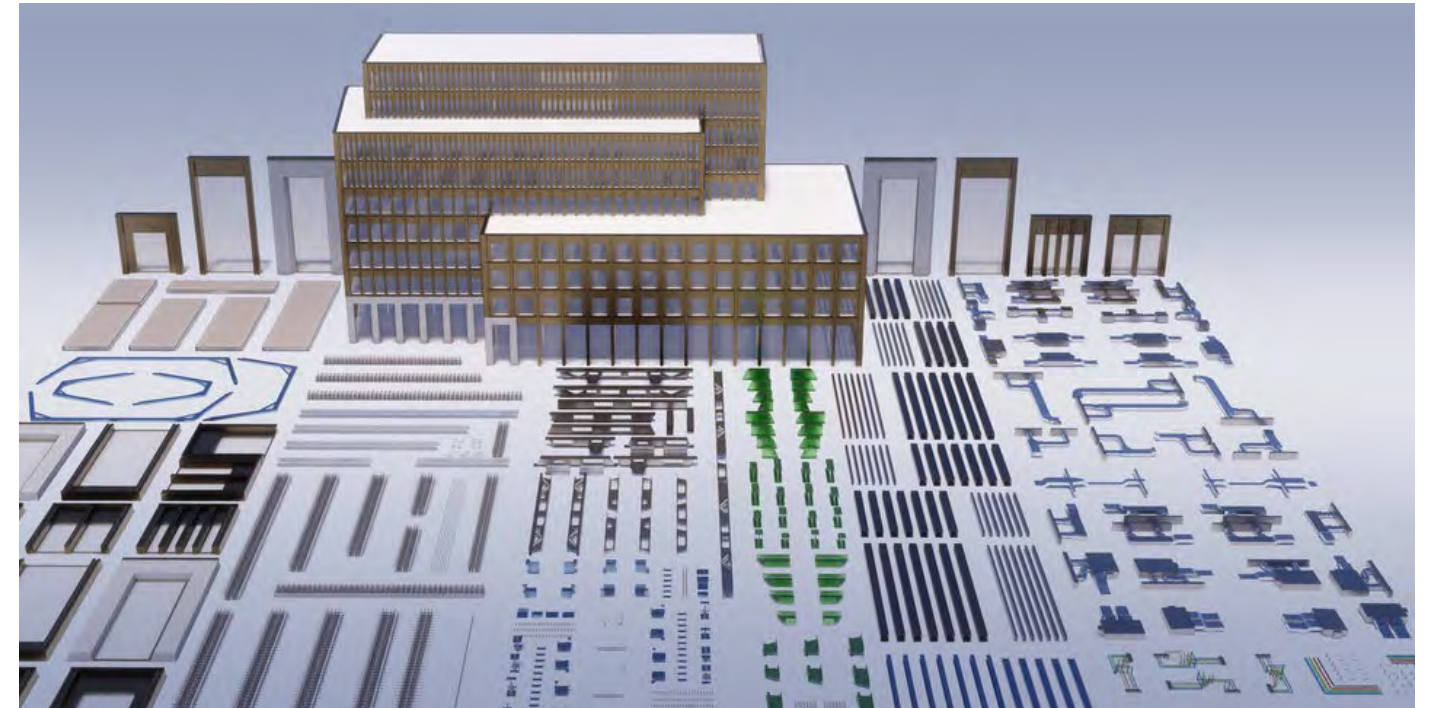
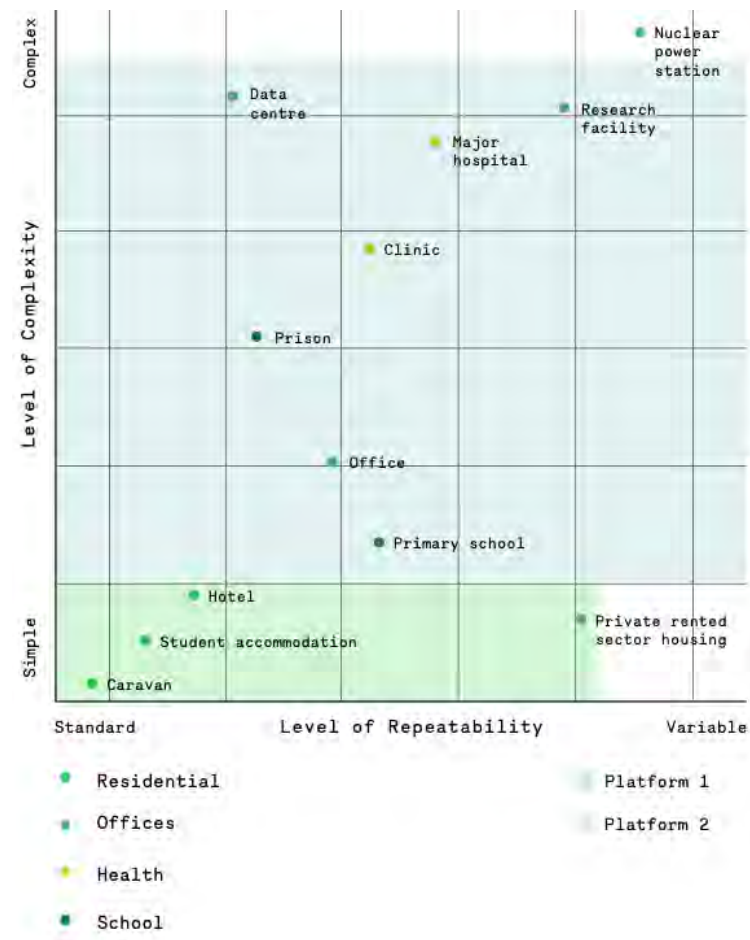

PLATFORM RULES AND APPROACH

Platform II was informed by analysis of the government estate (**demand aggregation and analysis**), specifically the physical dimensions of spaces, to identify areas of commonality (**a commonality strategy**) and thus the potential for mass customisation.

Incorporating both a **common, repeatable kit of parts** (physical components) and **repeatable processes** in design, procurement, manufacture and assembly, it is **deployable** across a broad range of social infrastructure.

Underpinned by principles of design for manufacture and assembly and based upon an open-source philosophy, the platform holds a **structured approach** to product and deployment **information**, that encourages interoperability.



6.1.3 CASE STUDY | GenZero - Department for Education

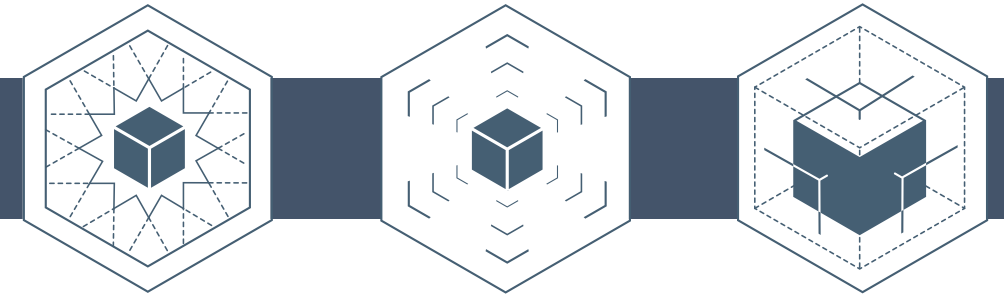

CASE STUDY: GENZERO - DEPARTMENT FOR EDUCATION

GenZero is a collaborative research project led by the Department for Education (DfE), Innovate UK and several private sector organisations to deliver an ultra-low carbon building and quality standard for schools.

This project has developed a platform to facilitate construction, landscaping and building operation choices that mitigate climate change and reduce environmental impact over a school's whole lifespan. It has achieved this by using renewable materials (timber and glulam), manufactured components, energy efficient principles (e.g. insulation, cross-ventilation) and sustainable energy solutions (heat pumps, solar PV).

Performance standards, across multiple building types, have been built into the platform's open source standards, along with a CQP (Critical Quality Point) process which any future additions to the platform are expected to meet.

Interfaces have been consciously designed to reduce material waste and maximise flexibility, accommodating variable design elements, unique to an individual schools (e.g. finishes, external cladding, loose or fixed furniture), without affecting the building's low-carbon credentials.

The standards built into the GenZero platform support the DfE's adoption of the S21 output specification, introduced in the contractor's framework for schools in November 2021, which made it compulsory for all new school buildings in England to be net-zero carbon in operation.



[>>CLICK HERE to learn more about GenZero](#)

PLATFORM RULES AND APPROACH

The GenZero initiative was driven by a **platform strategy**, to realise **measurable improvements** in sustainability, quality and other benefits within primary schools procured by the DfE (e.g. a **defined market segment**).

Across this portfolio, schools and classrooms were banded by range to support the definition and rationalisation of demand. This informed a **commonality strategy**, optimised to balance standardisation and appropriate variability. This included, for example, the development and use of 1800x900mm grid, as the smallest common unit, with everything nested within them.

The application of digital / BIM library workflows, embed standardised performance requirements into a rationalised set of spatial blocks.

Developed through an affiliated model, the **open** standards on building performance, optimised interfaces and critical quality point (CQP) provide a foundation for third parties to develop complementary products or technologies.

6.1.4 CASE STUDY | Mace - High Rise Solutions (HRS)

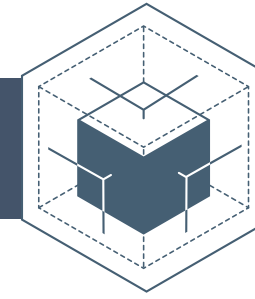
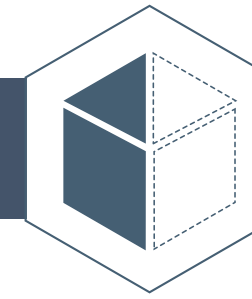

CASE STUDY: HIGH RISE SOLUTIONS (HRS)

Mace's HRS system is described as a next-generation construction method for high-rise residential buildings. Developed in partnership with Australian firm Hickory, the HRS system has been used initially to construct N06, a build-to-rent scheme in East Village, the former London 2012 Athletes' Village in Stratford, on behalf of client Get Living.

The HRS system combines the latest advances in digital technology with an offsite manufacturing approach to construct buildings faster, safer and to a consistently higher quality. At the centre of the system is a reinforced concrete frame, around which can be fitted integrated floors and façades, standardised precast elements (columns, cores, stairs, internal walls), and standardised fit-out elements (bathrooms, utility cupboards, wiring looms and internal serviced walls).

The use of a defined system means that there is a highly integrated design process between architect, engineer and contractor which consists predominantly of configuration. Parametric modelling tools and artificial intelligence are used to draw from a catalogue of common components to design and manufacture the structure and façade sub-assemblies offsite. There is an integrated supply chain for each of these common components, which is engaged and committed to continuous improvement and development of their products and the system. Manufacturing of these components takes place in an offsite assembly hub with preconfigured processes.

At N06 the system was able to reduce the length of design and construction programmes by 25%, vehicle movements by 40%, and waste by 70% compared to traditional methods. The project has been measured at 54% pre-manufactured value (PMV) by Cast.



PLATFORM RULES AND APPROACH

The development of the HRS system was informed by a **platform strategy**, focused on delivering improvements in time, quality, safety and carbon (amongst other benefits) within a **defined market segment** (e.g. high rise residential).

With **common repeatable processes**, **kit of parts** and **defined interfaces**, the HRS system has been developed through extensive testing and refinement (a design assurance process) to meet a quality standard that is deployable across multiple assets and configurable to individual project requirements.



[>> CLICK HERE to learn more about HRS](#)

6.1.5 CASE STUDY | NG Bailey - The Forge

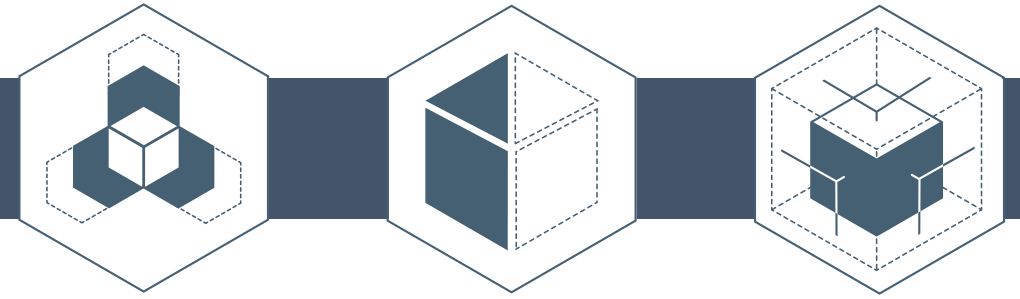

CASE STUDY: NG BAILEY – M&E KIT OF PARTS AT THE FORGE, LONDON

With 139,000 sq ft spread across nine-storeys, the Forge is the UK's first building to align with the UK Green Building Council's definition of net zero, built using a highly efficient and sustainable platform approach to design for manufacture and assembly.

Developed by Landsec and designed by Bryden Wood, the project brought together a collection of collaborative partners, including NG Bailey as Mechanical and Electrical (M&E) specialists. The project adopted an iteration to the Platform II system (outlined earlier) with a common, repeatable structural system, optimised across both structural and service zones to minimise slab-to-slab heights.

Maintaining a platform approach throughout, NG Bailey developed five common, repeatable Cat A M&E modules for pipework, fan coil units, lighting and acoustic ceilings and ductwork. By establishing and maintaining platform principles, these modules have been mass customised to produce 4658 units, rationalised to 171 module different configurations.

The use of common, repeatable modules has driven enhanced quality alongside efficiencies in the design, manufacture and assembly stages. As product platforms, the modules were part of a building prototype, developed at the Construction Platform Design Research Centre (a facility jointly developed by Bryden Wood and specialists Easi-space). This advanced testing created a feedback loop for design improvements and enabled development of a common, repeatable installation methodology.

The ability to test, validate and assure the manufacture and assembly of these offsite modules afforded enhanced project confidence and certainty, delivering measurable benefits such as a reduction in circa. 20,000 operative hours or save of 6 tonnes of CO₂ through avoidance of vehicle movements.



PLATFORM RULES AND APPROACH

Integrated with the P-DfMA structural design, NG Bailey has embedded a platform based approach within the M&E.

Applying an **output model**, NG Bailey assessed the profile of CAT A floorplate (evaluating the **demand**), the extent of variability of performance, systems and components and defined opportunities to harmonise and rationalise (a **commonality strategy**). This led to the creation of five module types (**product platforms**), delivered across 4658 individual modules.

Not only did the modules leverage a common design, but the methodology of assembly and **interface** with the structural system (e.g. bolting to precast inserts) was also standardised.

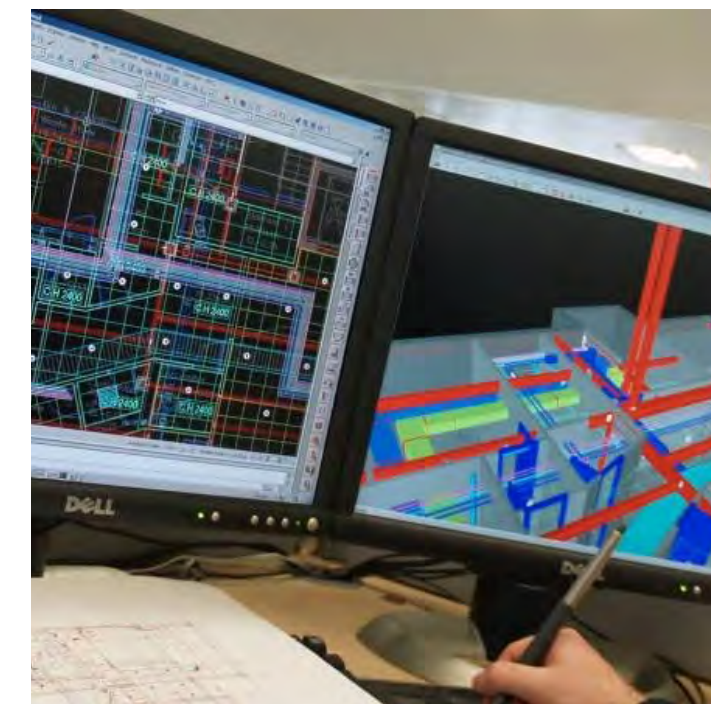

[>>CLICK HERE to learn more about the Forge](#)

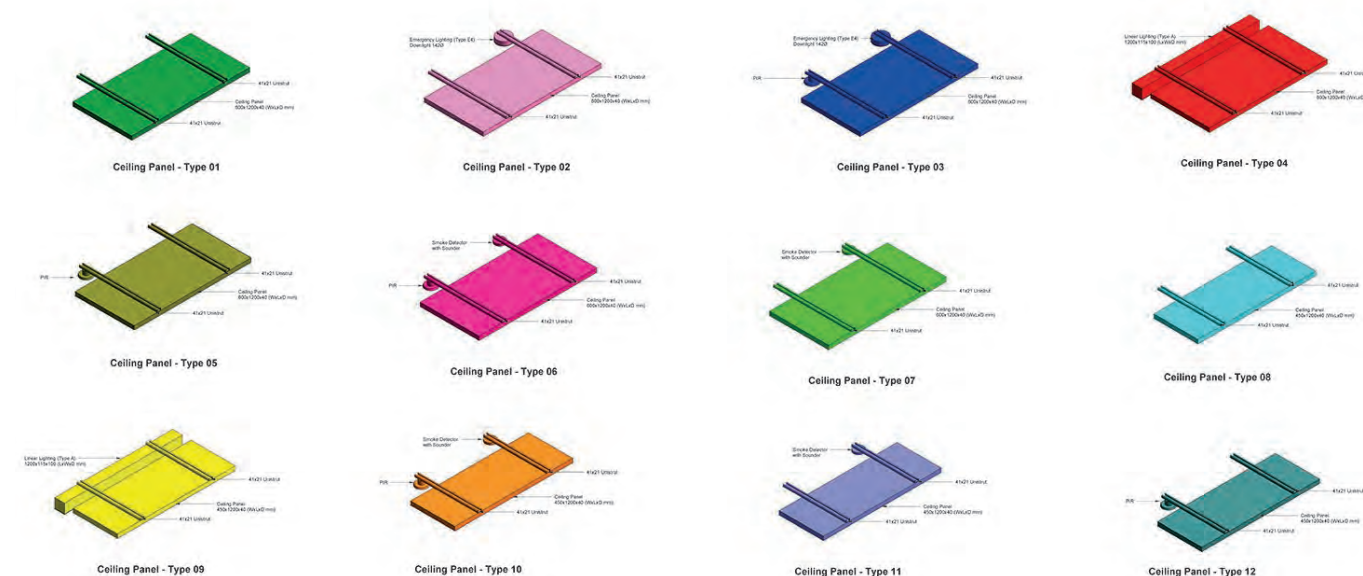

6.2. GUIDANCE ON CIRCULARITY

The adoption of Product Platforms in the Construction industry presents an opportunity to progress the sector, not only towards manufactured solutions, but also as a means to implement the fundamental principles of a circular economy.

The [Ellen MacArthur Foundation](#) defines circular economy, based on three principles, driven by design:

1. Eliminate waste and pollution
2. Circulate products and materials (at their highest value)
3. Regenerate nature

And states further that *“It is underpinned by a transition to renewable energy and materials. A circular economy decouples economic activity from the consumption of finite resources. It is a resilient system that is good for business, people and the environment.”*

The following statistic, further outlines the need for adoption of the circular economy for the built environment:

“The construction and operation buildings accounts for 37% of global greenhouse gas emissions currently. To make matters worse, around 95% of the value of construction materials is lost as buildings decay into obsolescence and then demolition. This is largely due to the ‘take, make, dispose’ model that is currently at the heart of the real estate and construction sectors.”

[Circular Buildings Toolkit - Arup](#)

The pressing need for the Built Environment to contribute to humanity changing course on its impact on the environment is further highlighted through the Stockholm Resilience Centre’s 9 [Planetary boundaries](#), [Doughnut Economics](#) and The UK Green Building Council:

“In 2015, the UK economy used 576 Mt of materials, and as far back as 1998 construction accounted for roughly half of our national material consumption. While most construction waste is now diverted from landfill, little is being recycled or reused, and the quantity of reused materials in construction has actually decreased since 1998”. (UK Green Building Council, 2019).

Developers of Product Platforms therefore have an opportunity to show leadership in changing the nature of the construction industry and its impact on the planet. Throughout the DEVELOP phase of the Rulebook process, designers must consider the embodied carbon in the materials that they chose to utilise, whilst optimising designs to meet the technical requirements of buildings, for example, design trade offs. Use of a systems engineering approach, such as completing a Quality Function Deployment (QFD) ensures that all of the customer requirements and functional characteristics are considered simultaneously, to identify these design engineering trade offs, such as reduction in material to reduce carbon vs the structural, acoustic or thermal performance of the building.

This guidance aims to signpost Product Platform Providers and adopters to existing toolsets, guides and frameworks, to ensure the principles of the circular economy are adopted.

Use of the Value Toolkit at the client and policy stage, will drive better social, environmental, and economic outcomes during both the delivery and operation of built assets. This can be used in conjunction with the principles of circular economy to drive for strategic outcomes, such as the impact of a Product Platform over its lifecycle and beyond first intended use.

The Value Toolkit supports faster value-based decision-making across the whole investment lifecycle for policy makers, advisors and clients. Creating a Value Profile with these stakeholders provides the market with a clear, consistent and transparent articulation of the core Value Drivers as they apply nationally, and for specific clients, projects or programmes. Such consistency will allow industry to invest strategically for the market, not just tactically for each project – bringing forward products, services and solutions which drive better value. The Value Toolkit enables strategic value drivers to be set and communicated at a national level, such as net zero and biodiversity initiatives. These national value drivers can then be cascaded to individual projects and programmes. Circular Economy principles must be at the heart of Value Profile definition.

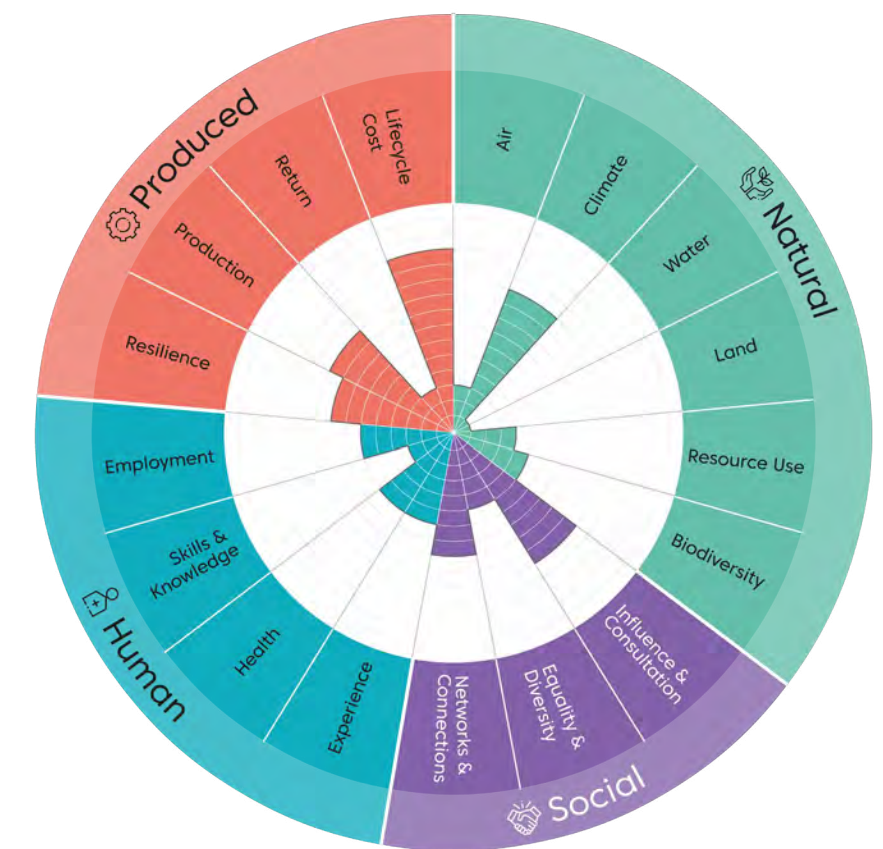

Fig. 6B: The Value Toolkit with the four capitals

CIRCULAR DESIGN PRINCIPLES

Product Platform adoption offers the opportunity to adopt the 11R resource hierarchy framework and move the built environment from the current state, linear economy to the future state, circular economy. Product Platform Providers (PPPs) have the potential to make the most impact at the design stage, as the end-of-life is often determined by decisions made at this stage.

The 11R Resource Management Hierarchy is a framework that can be utilised when at the design stage, to help make decisions on:

- Where the materials, components and parts are sourced from
- What materials the components and parts are made from (e.g. consider incorporation of secondary materials or future recyclability)
- Ease of maintenance and repair over the product's lifetime
- The interconnectivity and ability to disconnect the product from other building elements
- What is going to happen to the components of your product when it's intended life is complete

Figure 6-C shows the hierarchy of Rs, where picking a strategy higher up is preferred, however it often comes down to choosing what is relevant and achievable within your business model and product specification. It ensures the full life cycle is considered for of a product platform as well as the components and resources used for one. Designing in this way analyses both the physical asset and the business strategy – for a business to be truly circular, a holistic approach must be taken.

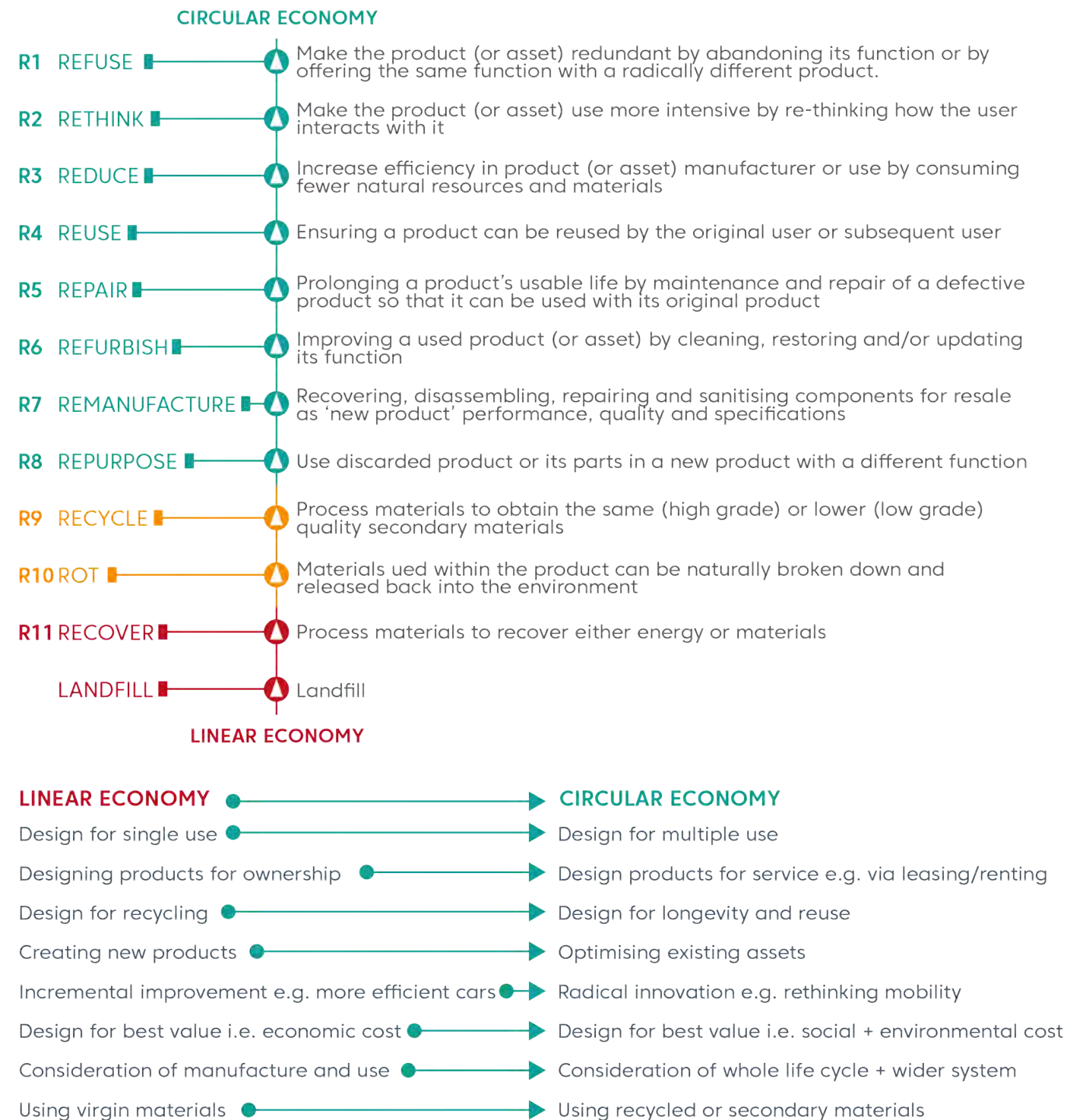

Fig. 6C: Moving from a linear to a circular economy [CE Hub](#)

SUSTAINABLE DESIGN

Sustainable design is the responsible, ethical implementation into a product and/or service – considering the social, economic and environmental impacts.

CIRCULAR DESIGN

Circular design is the technical embodiment of a product and/or service that encourages resource efficiency, in that it transitions away from the linear (take-make-waste) model towards a more regenerative cycle. ([MTC Definition](#))

VIRGIN OR PRIMARY MATERIALS

Materials that have not yet been used in the economy.

These include both finite materials (e.g. iron ore mined from the ground) and renewable resources (e.g. newly produced cotton). ([Ellen MacArthur Glossary](#))

NON-VIRGIN OR SECONDARY MATERIALS

Materials that have been previously used. This includes: materials in products that have been reused, refurbished or repaired; components that have been remanufactured; materials that have been recycled. Also referred to as secondary materials. ([Ellen MacArthur Glossary](#))

CLOSING THE LOOP

Throughout the development of a Product Platform, metrics and data should be generated to inform the designers, developers and users to make informed decisions on its carbon impact during deployment on a project or large programme of multiple buildings. Use of Lifecycle Assessments (LCAs) and Environmental Product Declarations (EPDs) can inform PPPs and Project Teams of their decisions and the amount of CO₂ generated throughout the project.

The construction sector, as with other sectors, must move to a future state of live data capture to ensure materials databases are continually updated with real world data. Traceability and provenance must be at the top of the agenda, to prove origin of primary and secondary sourced materials that are being used in built environment projects. Product Platform Providers should seek to adopt a business model that drives the circular economy and ensure the loop is closed on consumption of materials in the built environment.

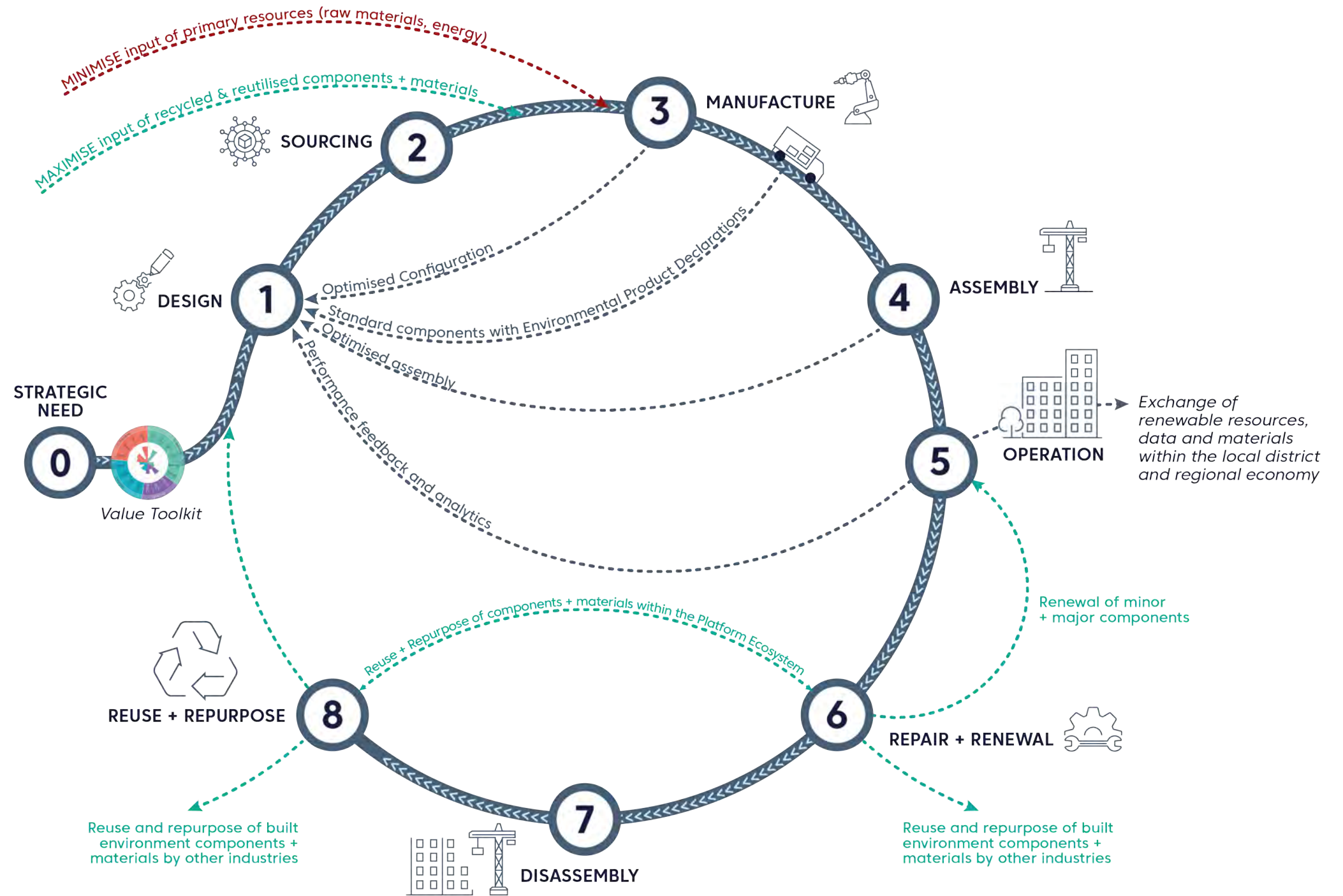

Fig. 6D: The Circular Economy

Adapted by Akerlof, with thanks to Arup's Circular Economy Report

MATERIALS PASSPORTS

The organisation Buildings as Materials Banks advocates for use of Material Passports as an enabler of a circular economy in the built environment. In the future state, digital technologies will evolve to ensure data follows the material flows within the circular economy.

BUILDINGS AS MATERIAL BANKS - MATERIALS PASSPORTS



The electronic Materials Passports developed in BAMB aim to be a one stop shop for material information. Materials Passports developed in BAMB are sets of data describing defined characteristics of materials in products that give them value for recovery and reuse.

[BAMB Materials Passports](#) aim to:

- Increase the value or keep the value of materials, products and components over time
- Create incentives for suppliers to produce healthy, sustainable and circular materials/building products
- Support materials choices in Reversible Building Design projects
- Make it easier for developers, managers and renovators to choose healthy, sustainable and circular building materials
- Facilitate reversed logistics and take back of products, materials and components

DESIGN FOR 'X'

Design for 'X' is a systematic approach used to optimise designs during the product development phase in order to focus on a specific improvement topic. Adopting Design for X shall enable PPPs to improve their product platform, based on specific topics, using this systematic approach enables the principles of the circular economy to be considered, during the design and product development phase. Some example focus topics, linked to the circular economy, are provided below.

Design for Manufacture and Assembly (DFMA) is an engineering methodology that focuses on reducing time-to-market and total production costs by prioritising both the ease of manufacture for the product's parts and the simplified assembly of those parts into the final product – all during the early design phases of the product lifecycle.

Design for Deconstruction (DfD) looks at how decisions made at the design stage can increase the quality and quantity of materials that can be re-used at the end of a building's life. This focus can be used in conjunction with DfMA in order to optimise construction products and product platforms for dis-assembly, maintenance and deconstruction. This enables re-circulation of materials, components and assemblies in the sector. SEDA's Design for Deconstruction is an example guide for designers.

Design for Standardisation focuses on the functional, interface, dimensional and geometric design of components and assemblies to, for example, rationalise the number of variants and drive commonality to achieve economies of scale, this is in line with a Product Platform approach. The [AIMCH](#) project highlights the benefits of adopting this design philosophy for an industrialised housing sector.

Design for Adaptability concentrates on the end of life of the building's first intended use. Guiding a designer to think about how the building can be retrofitted and modified in the future, increases the Reuse, Repair and Refurbishment of projects. ISO standard 20887 Sustainability in buildings and civil engineering works — Design for disassembly and adaptability — Principles, requirements and guidance is recommended.

Design for Resilience *Resilient design* is the intentional design of buildings, landscapes, communities, and regions, aimed at responding to natural and manmade disasters and disturbances as well as climate change—including sea level rise, heat waves, and regional drought, according to the Resilient Design Institute (RDI).

6.3. Further reading

POLICY

>>[Infrastructure Projects Authority Proposal for New Approach to Building - Summary of evidence \(2020\)](#)

>>[The Construction Playbook, Cabinet Office \(2020\)](#)

>>[Transforming Infrastructure Performance Roadmap to 2030, Infrastructure Project Authority \(2021\)](#)

PRODUCT PLATFORMS IN CONSTRUCTION

>>[Evidence submission to IPA's P-DfMA Call for Evidence, RIBA \(2019\)](#)

>>[Platform Thinking for Construction, Transforming Construction Network Plus Digest \(2020\)](#)

>>[Defining the Need, Construction Innovation Hub \(2020\)](#)

>>[Delivery Platforms for Government Assets, Bryden Wood \(2021\)](#)

>>[Platforms in Healthcare, Akerlof \(2021\)](#)

>>[Code for Construction Product Information, CCPi \(2021\)](#)

PLATFORM THINKING

>>[The Power of Product Platforms: Building Value and Cost Leadership by Meyer, M and Lehnerd, A. \(1997\)](#)

>>[Planning for Product Platforms by Robertson and Ulrich \(1998\)](#)

>>[Crafting Platform Strategy Based on Anticipated Benefits and Costs, Cameron, B.G, Crawley, E.F \(2014\)](#)

>>[Advances in Product Family and Product Platform Design. Springer, New York, NY. Simpson, T., Jiao, J., Siddique, Z., Hölttä-Otto, K. \(eds\) \(2014\)](#)

>>[Turn products into product platforms by John Hagel III, John Seely Brown \(JSB\), Maggie Wooll, Andrew de Maar \(2016\)](#)

>>[Product platforms as a lever of competitive advantage on a company-wide level: a resource management perspective Harland, P.E., Uddin, Z. & Laudien, S. Rev Manag Sci 14, 137–158 \(2020\)](#)

CIRCULARITY

>>[Circular economy - Mott MacDonald](#)

>>[System Enablers for a Circular Economy - UKGBC - UK Green Building Council](#)

>>[How Circular Economy Principles can impact carbon and value - UKGBC - UK Green Building Council](#)

>>[First steps towards a circular built environment \(ellenmacarthurfoundation.org\)](#)

>>[Low Carbon Concrete Routemap | Institution of Civil Engineers \(ICE\)](#)

>>[Design for Deconstruction – helping construction unlock the benefits of the Circular Economy | BRE Group](#)

CONSTRUCTION INNOVATION HUB OUTPUTS

PLATFORM PROGRAMME

>>[Defining the Need \(2021\)](#)

>>[The Specification Maturity Route Map \(2022\)](#)

CPQP

>>[Construction Product Quality Planning \(2022\)](#)

>>[CPQP Handbook \(2022\)](#)

>>[Construction Product Approval Process \(2022\)](#)

>>[CPQP Guide \(2022\)](#)

CPQP 9 GUIDES

>>[Quality Function Deployment \(2022\)](#)

>>[Process Flow Chart \(2022\)](#)

>>[Design for Manufacture and Assembly \(2022\)](#)

>>[Design Failure Mode and Effects Analysis \(2022\)](#)

>>[Process Failure Mode and Effects Analysis \(2022\)](#)

>>[Measurement System Analysis \(2022\)](#)

>>[Statistical Process Control \(2022\)](#)

>>[Control Plan \(2022\)](#)

>>[8 Disciplines of Problem Solving \(2022\)](#)

LEXICON METHODOLOGY

>>[LEXiCON Methodology: Creating relevant authorities and achieving consensus \(2022\)](#)

DIGITAL COMPLIANCE ECOSYSTEM

>>[Digital Compliance Ecosystem \(2021\)](#)

7. DEFINITIONS

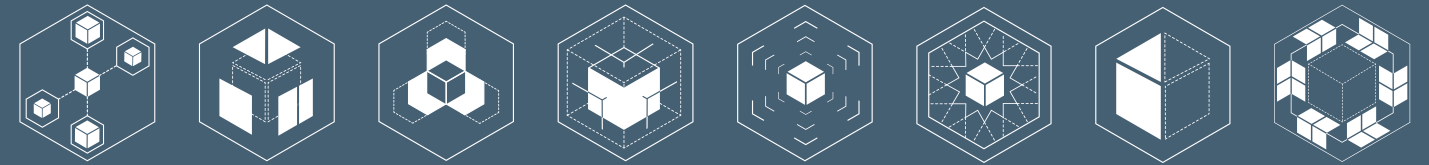

TERM	DEFINITION OR SOURCE DESCRIPTION
Assembly	A combination of components.
Component	A constituent part of a building (or other built asset) which is manufactured as an independent unit that can be joined or blended with other components to form a more complex item. Generally, components are 'self-contained' and sourced from a single supplier, typically the complete unit provided by that supplier rather than its constituent parts. (Source - designingbuildings.co.uk)
Demand <small>(As referenced within the Product Platform Development Framework)</small>	The use of product platforms requires aggregation of demand across a range of assets – typically where there are high volumes of similar features – and an ability to rationalise design requirements. This is done away from the project environment and is critical to establishing requirements and providing confidence to the supply chain that the solutions they develop will have a market.
Deploy <small>(As referenced within the Project Platform Development Framework)</small>	The development of product platforms happens away from the project environment and hence is not undertaken in relation to the requirements of one specific asset. The deployment of product platforms on projects therefore relies on how well the requirements collected during the develop stage reflect the specific needs of that project (and the flexibility of the product platform). Once a product platform is developed, a significant proportion of design is replaced by 'configuration' of these standardised components and assemblies, although an element of bespoke design is always likely to be required. A Product Platform Deployment Manual will be produced for each particular product platform using the Product Platform Rulebook.
Develop <small>(As referenced within the Product Platform Development Framework)</small>	It is expected that there will be multiple product platforms serving different market segments and client requirements (and hence deliver different performance and value). The process through which product platforms are developed is not widely understood or consistent in construction. The product platform rulebook will set out this process, ensuring different product platforms use the same language, share the same data, and thus allow for comparison, ease of configuration, and levels of interoperability/interchange. The Hub is also working with existing product platform providers to identify early opportunities for standardisation and interoperability. As part of the develop stage, all product platforms will produce a Product Platform Specification and Deployment Manual in line with the Product Platform Rulebook.

TERM	DEFINITION OR SOURCE DESCRIPTION
Harmonise, Digitise and Rationalise <small>(As referenced within the Construction Playbook and TIP Roadmap to 2030)</small>	The Construction Playbook states that <i>“Contracting authorities should seek opportunities to collaborate in order to develop and adopt shared requirements and common standards. This should be done to enable standardised and interoperable components from a variety of suppliers to be used across a range of public works. This will create a more resilient pipeline and drive efficiencies, innovation and productivity in the sector.”</i>
Kit of Parts	A collection of repeatable, standardised building components that are pre-engineered and designed to create a variety of assemblies which define part or all of a finished building.
Platform	A term that is widely used but with consistent elements including: a set of low variety core assets (i.e. components, processes, knowledge, people and relationships); a complementary set of peripheral components that exhibit high variety; stable interfaces that act as a bridge between the stable core and variable peripherals; and a set of rules or standards governing how components can be integrated.
Platform Programme	Overarching tag for all Hub programme work relating to platforms.
Principles	Within the Product Platform Rulebook, the Principles are requirements which should be applied in conjunction with the Rules. Compliance with the Rules determines whether something can be considered a product platform or not. Performance against the Principles determines how advanced a product platform is.
Product Platform (PP)	A kit of parts, associated production processes, and the knowledge, people and relationships required to deliver all or part of construction projects using a platform approach. A product platform provides a stable core which is configured and combined with complementary components (via defined interfaces) to suit a particular project. A product platform also includes the processes tools and equipment required for assembly.

TERM	DEFINITION OR SOURCE DESCRIPTION
Product Platform Definition	Rules which define the boundaries of a particular product platform, developed using the Product Platform Rulebook and defining key drivers, objectives, requirements and architecture.
Product Platform Deployment Manual	The manual for deploying a specific product platform in a project setting, including configuration, ordering, supply chain management, assembly and how complementary components interface to form all or part of a finished building.
Product Platform Development Framework	A common framework to support the development of product platforms. The framework sets out a series of activities across three stages (Demand, Develop, Deploy) covering the identification of market demand through the development of a product platform to its eventual deployment on multiple projects. The Product Platform Development Framework is governed by the Product Platform Rulebook.
Product Platform Roadmap	A detailed breakdown of activities to inform planning and investment decisions, that sets out the order in which the product platform provider needs to develop product families and constituent parts.
Product Platform Rulebook (The Rulebook)	Rules, requirements and a guide to the development of all product platforms in construction.
Product Platform Specification	The component, interface and production specifications for a particular product platform, developed using the Product Platform Rulebook and based on the rules set out in the Product Platform Definition.
Rules	Within the Product Platform Rulebook, the Rules comprise general statements and definitions for which there is no alternative; as well as requirements for which no alternative is permitted unless specifically stated. Compliance with the Rules determines whether something can be considered a product platform or not.

THE RULES & PRINCIPLES



1. DEPLOYABLE



2. CONFIGURABLE



3. COMMON
REPEATABLE
ELEMENTS



4. INTERFACES



5. OPEN

THE RULES



6. QUALITY

THE PRINCIPLES



7. STRUCTURED
INFORMATION



8. CIRCULAR

The Hub, and its partners in developing this Rulebook - Akerlof, Atkins, Mott MacDonald and Churton Studio - would like to thank the following organisations for their participation and input:

Active Building Centre
Adept Management
Advanced Manufacturing Research Centre
Akerlof
Algeco UK
Allford Hall Monaghan Morris
Allies and Morrison
ARK Consultancy
Association for Consultancy and Engineering (ACE)
Aston University
Atkins
Balfour Beatty
BAM Construct UK
BAM Design
BD Solutions
BecoWallform
Blaac
BMI Group
Bryden Wood
BSI Group
Build Eco
Build Offsite
BuroHappold
Cast Consultancy
Churton Studio
CIOB
Civil Engineering Contractors Association
Cogital
Connected Places Catapult
Construction Leadership Council
Construction Products Association
Construction Scotland Innovation Centre
Cornerstone Assets
Costain
Crown Commercial Services
Department for Education
Department of Levelling Up, Housing and Communities
Eco Build
EcoLogic Homes
Environment Agency
Foot Anstey LLP
Get It Right Initiative
Global Apartment Advisors
Graham
Grimshaw
Hertfordshire Local Enterprise Partnership
HLM Architects
Ilke Homes
Imperial College London
Infrastructure and Projects Authority
Innovate UK
Insight Futures
Inventt
Kier
KPMG
L&Q Group
Labit Group
Laing O'Rourke
LandSec
Lewisford Associates
LHC
Loughborough University
Mace
M-A-R Offsite
Mark Fenton Design Services
McAvoy Group
McLaughlin & Harvey
Ministry of Defence
Ministry of Justice
Modular Building Developments
Modularize
Morgan Sindall Group
Mott MacDonald
National Composites Centre
National House Building Council
NG Bailey
Offsite Alliance
Operance
Polypipe
Positive Homes
Ramboll
RIBA
RICS
Roger Bullivant
Royal Town Planning Institute
Saxon CBE
Scottish Water
Sir Robert McAlpine
SISK Group
Skanska
Spirel Ltd
Stewart Milne
Supply Chain Sustainability School
The Construction Industry Training Board
The Government of Wales
The University of Warwick
TopHat
Transforming Construction Network Plus
UCL
University of Cambridge
University of Wolverhampton
Vinci Construction
Vista Insurance Brokers
Watford Community Housing
Willmott Dixon
WSP
Zurich





**CONSTRUCTION
INNOVATION HUB**