



TOOLSET
GUIDELINE
4

Design Failure Mode and Effects Analysis Guideline

Version 1.0

August 2022

Contents

Use of this Guide	5
Introduction	7
Purpose	7
Benefits	8
How does DFMEA fit in with Construction Product Quality Planning?	9
Methodology	11
Key Steps in Performing a DFMEA	12
Planning for the DFMEA	12
Inputs and Outputs	13
DFMEA Data	13
DFMEA Tools	14
	15
Guideline	
Guideline	20
Step 1: Populate the Item or Function	21
Step 2: Identify Expected Requirements of Item Function	21
Step 3: Brainstorm Potential Failure Modes	21
Step 4: Brainstorm Potential Failure Mode Effects	22
Step 5: Apply Severity Number (SEV) and Characteristics	23
Step 6: Define Potential Failure Mode Cause(s)	24
Step 7: Apply Occurrence Number (OCC)	26
Step 8: Identify Prevention and Detection Controls	27
Step 9: Apply Detection (DEC) Number	29
Step 10: Calculate Risk Priority Number (RPN)	30
Step 11: Develop an Improvement Action Plan & Execute	32
	34
References and Appendices	
References	37
Appendix A. Tool Templates	38
Appendix B. List of Abbreviations	39
Appendix C. Glossary of Terms	39
	39

List of figures

Figure 1. Cost/Effect/Effort diagram – CPQP design process versus traditional design process	7
Figure 2. New product introduction stages	8
Figure 3. Role of the DFMEA	9
Figure 4. DFMEA key process steps	11
Figure 5. DFMEA typical inputs and outputs	12
Figure 6. Boundary Diagram Example	15
Figure 7. Interface Matrix Example	16
Figure 8. Parameter diagram example with descriptions	17
Figure 9. Functional Block Diagram example	18
Figure 10. DFMEA step 1 outcome example – populate the item and function	20
Figure 11. DFMEA step 2 outcome example - identify expected requirements	20
Figure 12. DFMEA step 3 outcome example - brainstorm potential failure modes	21
Figure 13. DFMEA step 4 outcome example - brainstorm potential failure mode effects	22
Figure 14. DFMEA step 5 outcome example - apply SEV number, characteristics	24
Figure 15. DFMEA step 6 outcome example - define potential failure mode cause(s)	25
Figure 16. DFMEA step 7 outcome example - apply an OCC number	27
Figure 17. DFMEA step 8 outcome example - identify prevention and detection controls	28
Figure 18. DFMEA step 9 outcome example - apply a DET number	30
Figure 19. DFMEA RPN calculation guide	31
Figure 20. DFMEA step 10 outcome example – RPN calculation	32
Figure 21. DFMEA step 11 outcome example – sample improvement actions	33

List of tables

Table 1. Typical cost increase associated with failing to identify a design issue at the earliest possible stage	8
Table 2. DFMEA Standard headings and data sources	14
Table 3. DFMEA severity evaluation criteria	24
Table 4. Key Characteristics definition	25
Table 5. DFMEA occurrence evaluation criteria	27
Table 6: DFMEA detection evaluation criteria	30

Use of this Guide

The Design Failure Mode and Effects Analysis (DFMEA) guideline is part of the Construction Product Quality Planning (CPQP) process and should be used in conjunction with the CPQP Guide and its toolset, published by the Construction Innovation Hub.

This document is intended to be a guideline to aid the process of creating a Design Failure Mode and Effects Analysis (DFMEA), presenting the basic principles and a suggested methodology. The templates provided may be changed and modified to suit individual companies.

This guideline is aimed at companies that manufacture offsite construction products

and use the CPQP process with their customers and suppliers. It is intended to provide enough knowledge to enable the CPQP team to complete a DFMEA, particularly where this subject is new to them, as well as to provide ongoing aid. Over time, companies will develop their own expertise, methods and standards through training and practice.

For a list of the acronyms and abbreviations used in this document, refer to Appendix B – List of Abbreviations.

For the various terms used in this document, refer to Appendix C – Glossary of Terms.

For further information about the CPQP Guide and its toolset please contact:
cpqp@constructioninnovationhub.org.uk



Introduction

Introduction

Design Failure Mode and Effects Analysis (DFMEA) is a structured approach used by engineers to identify potential failures that could occur in the design of a product. DFMEA has been developed specifically for product design using the Failure Mode and Effects Analysis (FMEA) methodology.

DFMEA is a risk evaluation tool that seeks to:

1. Identify design functions and requirements;
2. Identify the possible failure modes of the design;
3. Identify the causes of the failure modes and their occurrence;
4. Identify the effects of those failures and their severity;
5. Identify the likelihood to prevent and detect the failures;
6. Identify actions and their priorities; and
7. Review Risk Priority Number (RPN) scores before and after any improvement actions have been carried out.

DFMEA should be carried out using cross-functional teams.

A DFMEA is a live document that captures the key functions in a design and analyses the potential causes of failure modes and their associated risk. It defines what could go wrong with the design, how bad the effect might be, and how to prevent or control it.

Purpose

DFMEA is designed to reduce the risk of a design failure and does this by:

- Evaluating the initial design and potential design alternatives;
- Identifying, quantifying, and reducing design risk;
- Evaluating the initial design for manufacturing, assembly, in-service, and recycling requirements;
- Developing a prioritised list of potential failure modes and effects;
- Defining and guiding a methodical design process;
- Justifying design choices; and
- Providing means for continuous product improvement and source for future reference in a form of a traceable document.

The DFMEA, as a live document, should:

- Begin before concept design completion;
- Be updated as new information becomes available or design changes occur;
- Be fundamentally complete before release of the design for manufacture; and
- Be a source of lessons learnt for future design iterations.

Benefits

Performing a DFMEA is a good, cost-effective practice to identify risks associated with product and process design as early in the design and development stages as possible. Early identification of risk gives a greater ability to impact design functionality. Additionally, the longer it takes to identify a problem, the costlier it is to correct it, as shown in Figure 1.

Performing a DFMEA on a new or existing product design enables:

- Reduced cost of design improvements;
- Increased product reliability;
- Reduced development and manufacturing cost; and
- Increased customer satisfaction.

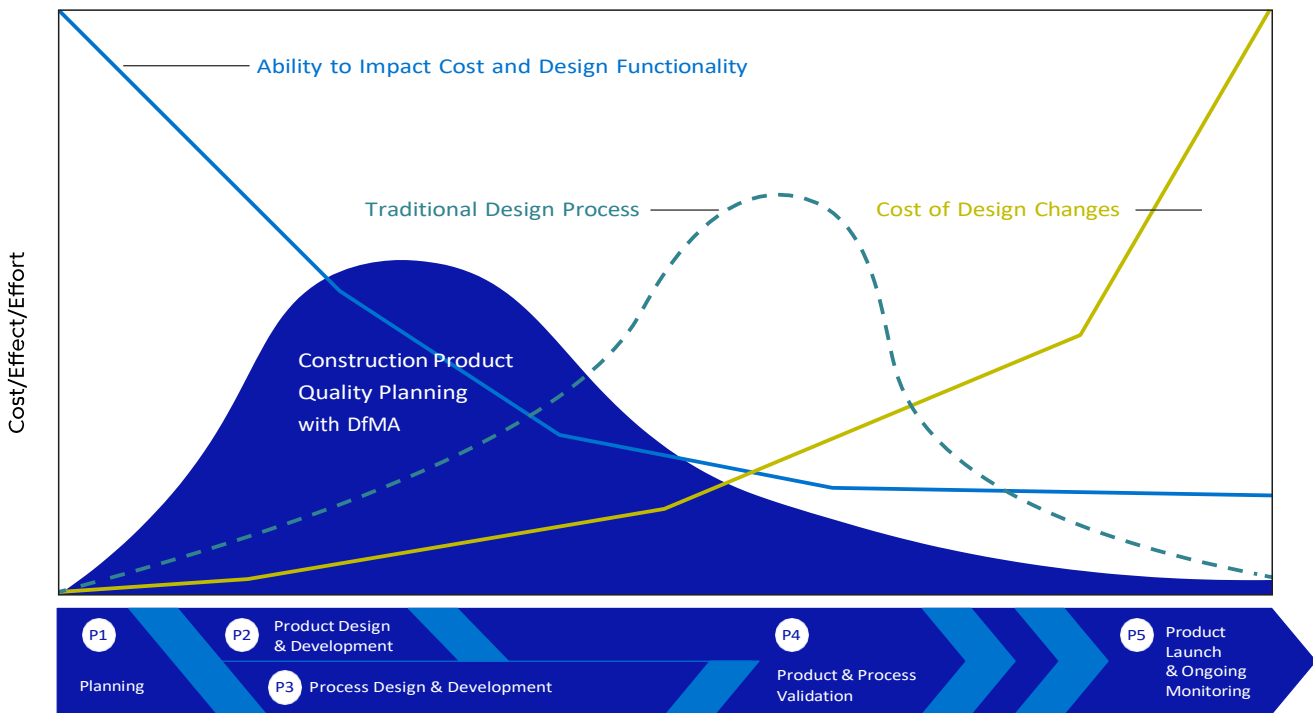

Figure 1. Cost/Effect/Effort diagram – CPQP design process versus traditional design process

Stage	Cost to Identify & Solve Issue
Feasibility	0 X
Design	10 X
Development	100 X
Testing	1000 X
Manufacturing	10,000 X
At Customer	100,000 X

Table 1. Typical cost increase associated with failing to identify a design issue at the earliest possible stage

How does DFMEA fit in with Construction Product Quality Planning?

DFMEA is applied when:

- Designing a new product;
- Modifying or updating a product design; and
- Using a current product design in a new environment.

DFMEA is typically carried out at three levels:

- **System**
A collection of subsystems that together provide all the required functionality of a design;
- **Sub-system**
A collection of components that in combination provide a specific function; and

- **Component**
The simplest physical or virtual unit of a design.

A DFMEA is developed in the early stages of the CPQP process shown Figure 2. It will have the biggest impact at the start of the product design stage. It is a deliverable of Phase 2 (Product Design and Development) in CPQP. During this stage, the DFMEA is a live document, open to revisions as new information becomes available or when design changes are made. A final review takes place during the design review at the end of Phase 2. After this point, any further changes to the DFMEA would have to go through a controlled

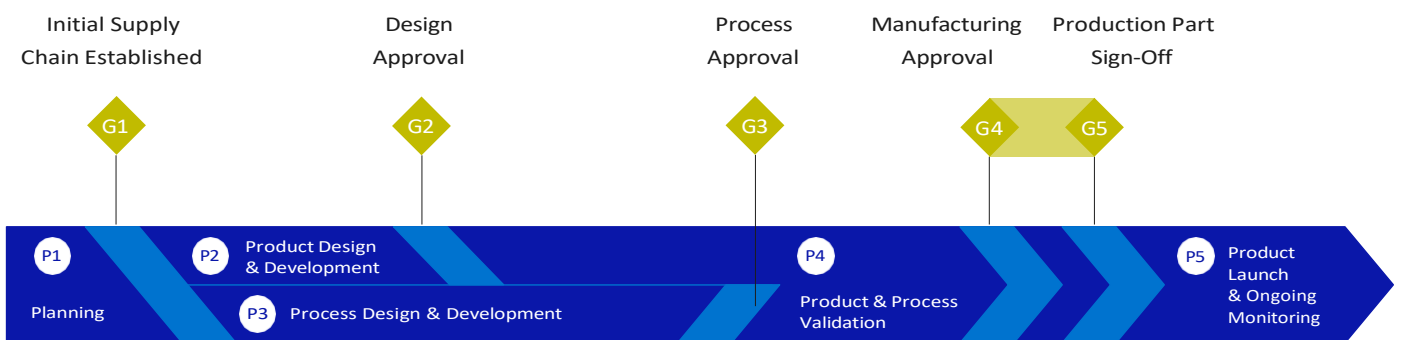

Figure 2. New product introduction stages [1]

design change process. As long as the product is being manufactured, the DFMEA should not be retired as a need for design change may arise.

Figure 3 illustrates the inputs and key outputs of a DFMEA as well as the information flow in the process.

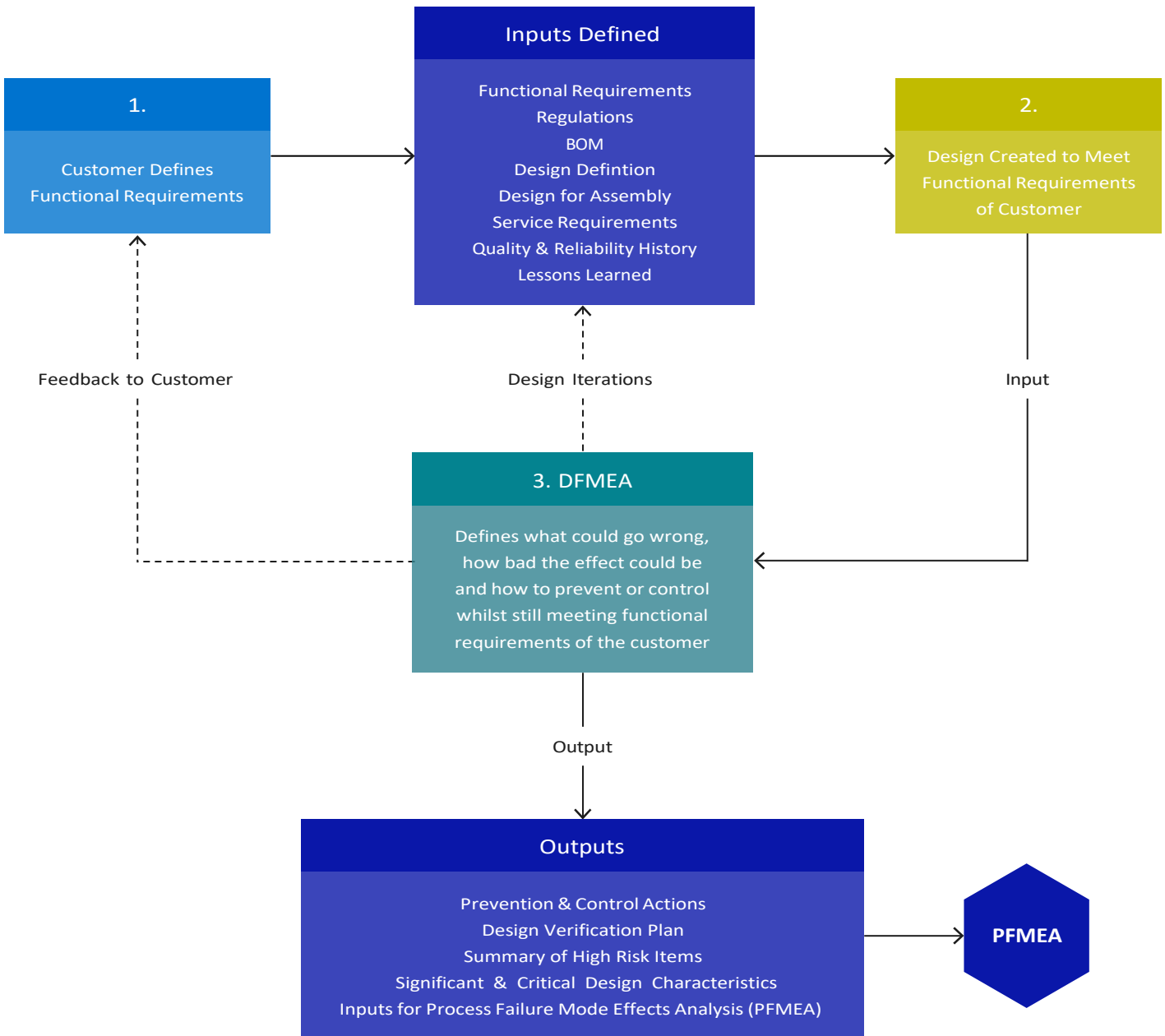

Figure 3. Role of the DFMEA



Methodology

Methodology

Key steps in performing a DFMEA

In order to complete a DFMEA, 11 steps must be followed, as per Figure 4.

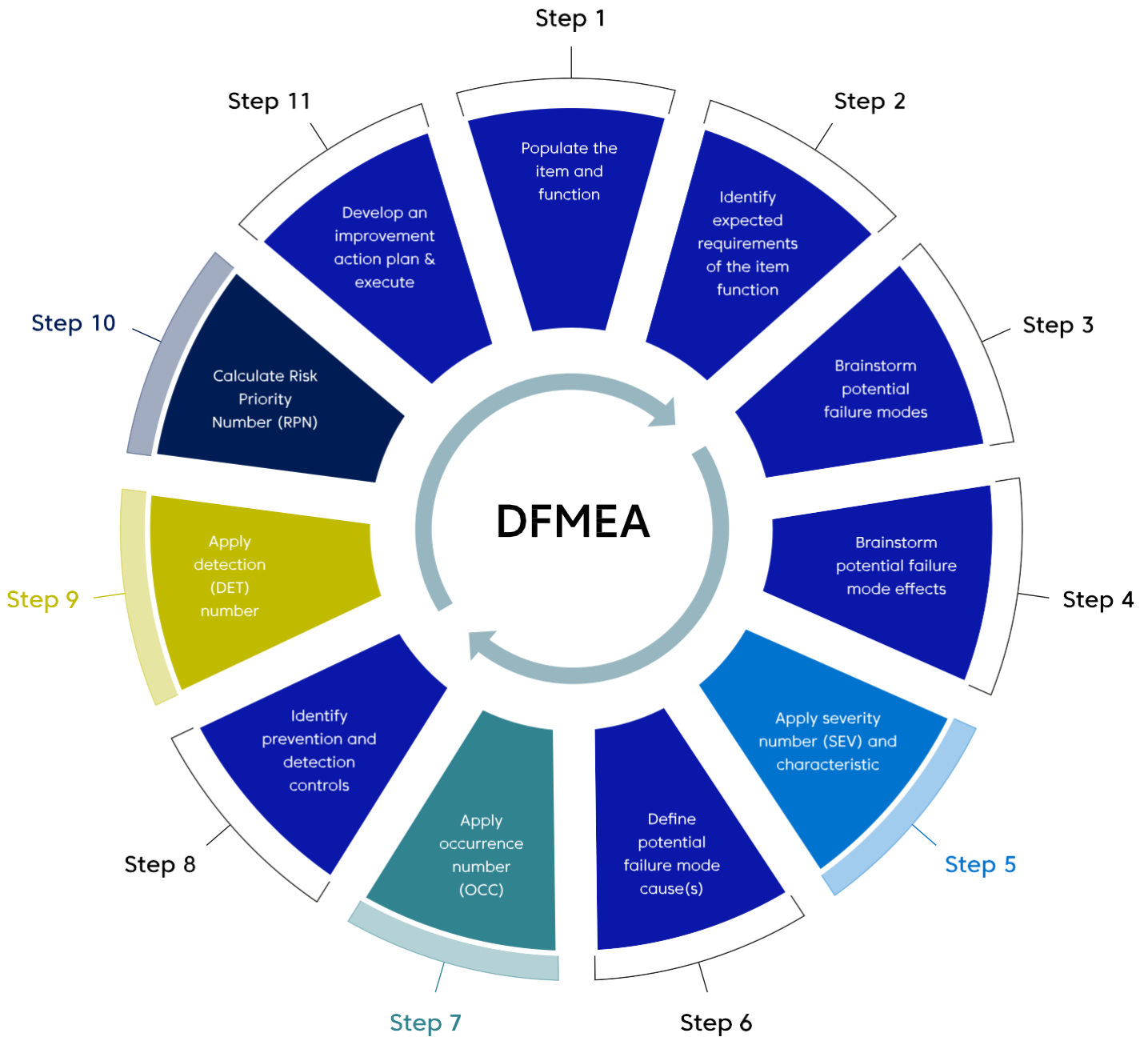

Figure 4. DFMEA key process steps

Planning for the DFMEA

To perform a successful DMFEA, a cross-functional team, trained in use and development of the tool, should be deployed. This will reduce the risk of over-sights by ensuring a diversity of views are taken into account and providing a multi-disciplinary expertise and input.

A well-defined, cross-functional team should include representatives from, but not limited to:

- Experienced facilitator;
- Customer;
- Design Engineering;
- Product Safety;

- Manufacturing;
- Assembly;
- Testing;
- Materials;
- Quality;
- Service/Maintenance (in the field); and
- Suppliers.

Inputs and Outputs

There are a number of key inputs required to complete the DFMEA and a number of key outputs generated from it, as illustrated in Figure 5.

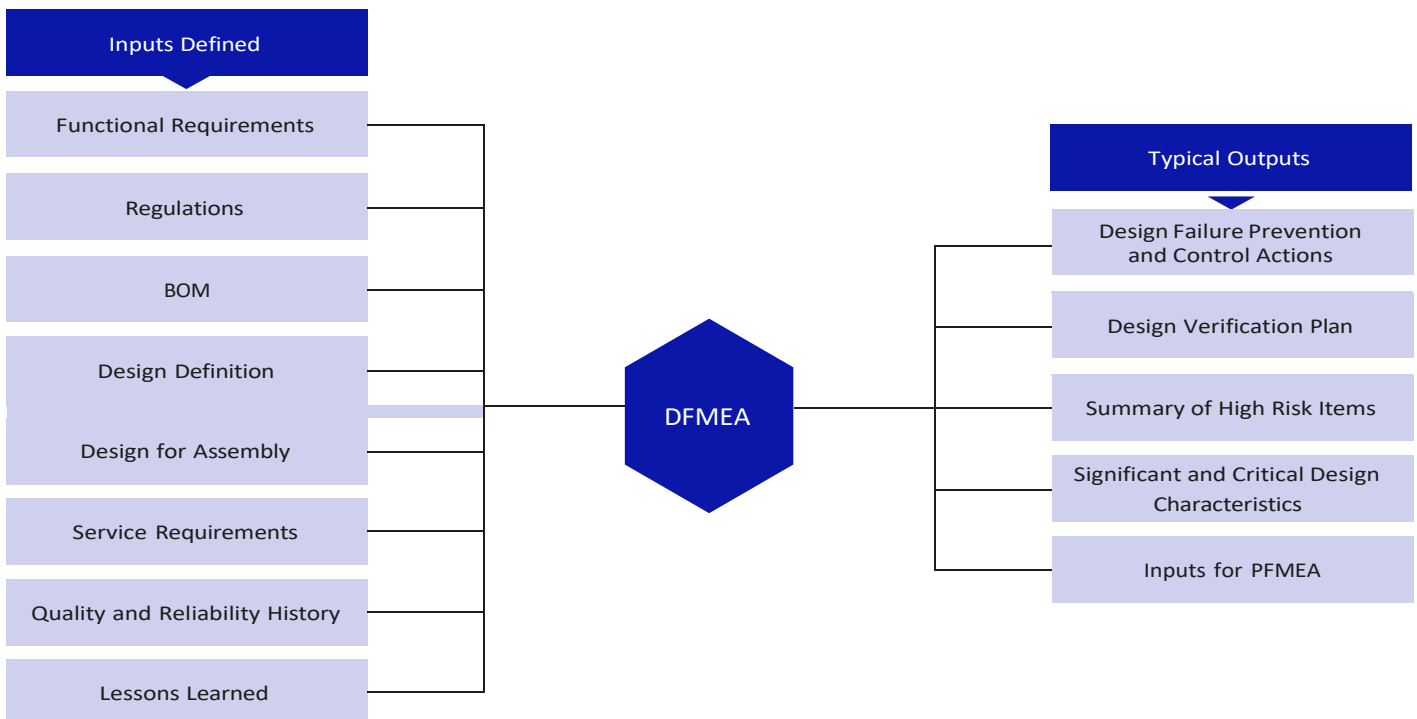

Figure 5. DFMEA typical inputs and outputs

DFMEA Data

A standard template is used to create the DFMEA. Table 2 shows the headings of the DFMEA template and details the sources of the data.

DFMEA Heading	Description	Typical data source
Item	The system/sub-system/component that is being considered for this part of the DFMEA	Design
Function	The function or functions of the item being considered	Drawing, specifications, customer requirements
Requirements	The requirement for that function	Drawing, specifications, customer requirements, design standards
Potential failure mode	The way the design of the item under consideration may fail to meet the function and requirement	Team knowledge, similar products, past DFMEA, boundary diagrams
Potential failure mode effect	The effects of the failure mode on the end user or customer if the design fails to meet its function	Team knowledge, similar products, past DFMEA
SEV (Severity)	The severity of the failure effect on the product to the end user or customer	Team knowledge, similar products, past DFMEA, ref. tables
Classification	The product feature Key Classifications (Critical Characteristic (CC) or Significant Characteristic (SC)) in terms of how important they are to safety, performance or regulation	Key Characteristic (KC) definition and severity rating e.g., Table 4. Key Characteristics definition
Potential failure mode cause	The product feature Key Classifications (Critical Characteristic (CC) or Significant Characteristic (SC)) in terms of how important they are to safety, performance or regulation	Team knowledge, similar products, past DFMEA
OCC (Occurrence)	The likelihood (potential) for the failure to occur, i.e. how often it will happen	Previous design failures, team knowledge, similar products, past DFMEA, ref. tables
Prevention of potential failure mode cause	The controls that exist in the design process that stop the failure mode from occurring or prevent it from being present in the released design	Design methods, standards, team knowledge, similar products, past DFMEA
Detection of potential failure mode occurrence	The controls that exist in the design process that detect the failure mode if it occurred in the design	Design methods, standards, testing processes, team knowledge, similar products, past DFMEA
DET (Detection)	The likelihood (potential) for the failure to be detected	Design methods, standards, testing processes, team knowledge, similar products, past DFMEA, ref. tables
RPN	The RPN is calculated as $SEV \times OCC \times DET$	This is an output of the DFMEA
Recommended improvement/ corrective actions	The corrective actions for items with high RPNs or high severity	This is an output of the DFMEA

Table 2. DFMEA Standard headings and data sources

DFMEA Tools

There are four tools that can be used to aid and identify the scope of a DFMEA:

- Boundary Diagram;
- Interface Matrix;
- P-Diagram; and
- Functional Block Diagram.

As each tool brings its own unique contribution to a DFMEA, it is important to know when to use the various tools.

Note: An interface is the point or surface where two components, sub-systems, or systems meet.

Primary interface types include:

- **Physical connection**
Brackets, bolts, clamps, etc.;
- **Material exchange**
Pneumatic fluids, hydraulic fluids, etc.;
- **Energy transfer**
Heat transfer, friction, motion transfer, etc.; and
- **Data exchange**
Computer inputs or outputs, wiring harnesses, electrical signals, etc.

Boundary Diagram

It is important to understand the relationships between components and sub-systems within a system, as well as interfaces with other systems and environments. A Boundary Diagram consists of blocks containing the name of a component, sub-system, or interface, and with lines connecting blocks where there is a connection.

A Boundary Diagram helps define the scope of each DFMEA, sorting the DFMEA into manageable levels. It should:

- Identify major components, subsystems and interfaces;
- Identify how they interact with one another; and
- Identify how they interact with any bordering systems.

A Boundary Diagram will start with the block and interfaces at a system level. It expands as the design develops with additional diagrams to show sub-system and component levels, as shown in Figure 6.

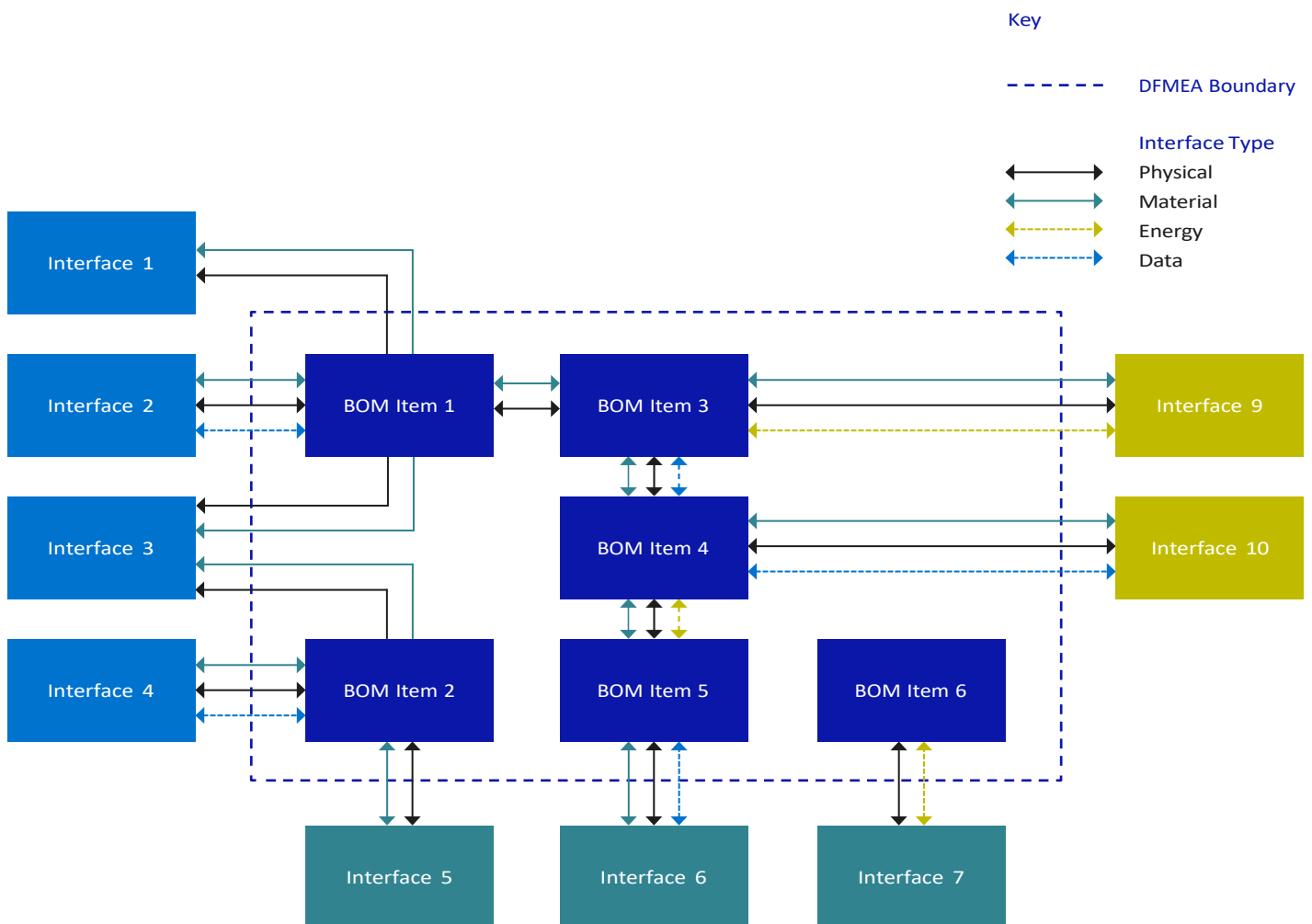

Table 2. DFMEA Standard headings and data sources

Interface Matrix

An Interface Matrix is a chart with all components, sub-systems, and systems listed on both the vertical and horizontal axes. The chart identifies the interface types that must be considered during the DFMEA.

When used with a DFMEA, the Interface Matrix is supplementary to the Boundary Diagram and is completed to ensure all interfaces have been captured. It is a good practice to assign identifiers to each interface to link them to the corresponding functions in the DFMEA, as shown in Figure 7.

	Output	BOM Item 1	BOM Item 2	BOM Item 3	BOM Item 4	BOM Item 5	BOM Item 6
Input							
BOM Item 1			PME1	PM1			
BOM Item 2		PME1			PM1		
BOM Item 3		PM1					PM1
BOM Item 4			PM1	PME1		PMD1	
BOM Item 5					PMD1		
BOM Item 6				PM1			

Interface Type	Functional Necessity
Physical (P)	Must be Present (1)
Material Exchange (M)	Must not be Present (2)
Energy Transfer (E)	
Data Transfer (D)	

Figure 7. Interface Matrix Example

P-Diagram

The P-Diagram is a block diagram that shows the connections between different parameters of a system. The input signals from a system and the functions or outputs produced by a component being evaluated are identified in the P-Diagram.

The P-Diagram also captures the undesirable outputs, noise factors that will reduce the

effectiveness of the ideal functions and outputs. Design elements of a component are listed as control factors that will influence the designs robustness to the noise factors and minimise the effects of the undesirable output. System, sub-systems, components, and their functions are described and visualised in a simplistic way, as shown in Figure 8.

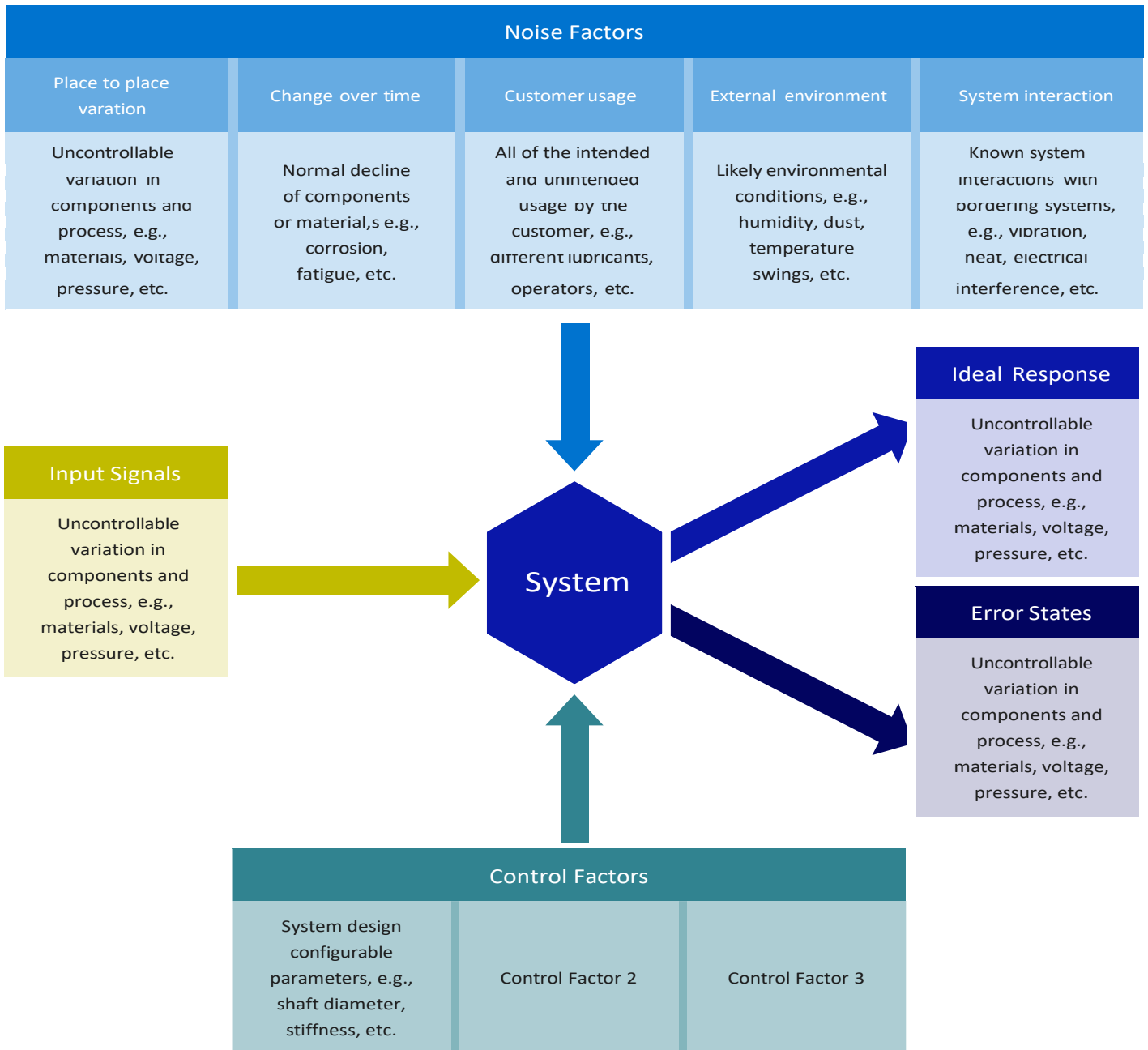

Figure 8. Parameter diagram example with descriptions

Functional Block Diagram

A Functional Block Diagram describes the operation, interrelationships, and interdependencies of the functions of a system. It does this by highlighting systems' primary functions.

A Functional Block Diagram is created before the DFMEA begins and it serves as an aid to a DFMEA process. Each diagram block houses a primary function and is sequentially laid out in the order performed. For clarity, inputs and outputs are also added, as shown in Figure 9.

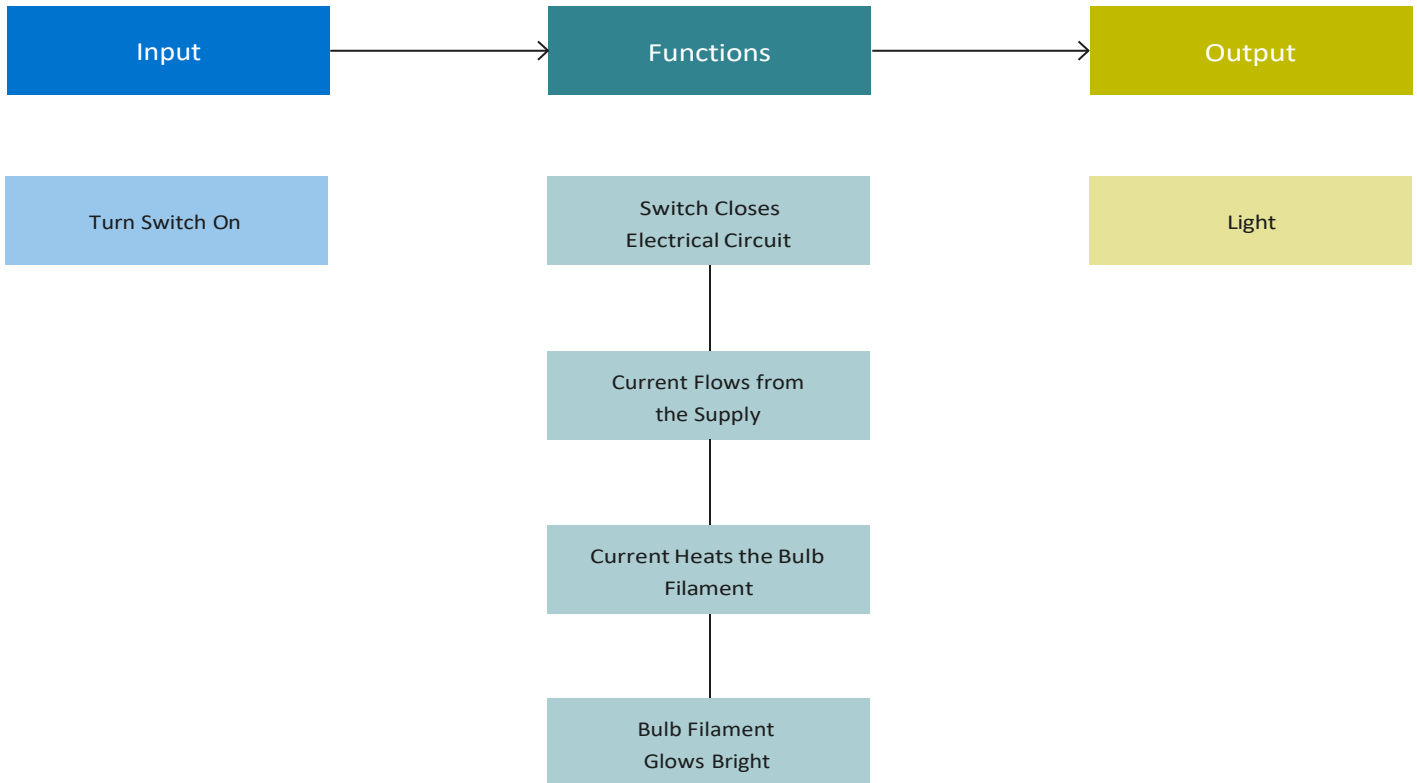

Figure 9. Functional Block Diagram example



Guideline

Guideline

Complete a DFMEA by following the 11 steps outlined in Figure 4.

When filling in the template it is important to describe each element in sufficient detail whilst keeping it concise. Known data should be used and appropriate references to other documents, standards, drawings made.

The key DFMEA steps are described herein using a simple example. Further details and a link to the complete worked example can be found in Appendix A.

Step 1: Populate the item and function

Review the design and populate the item and functions columns, listing each function separately, as it is shown in Figure 10.

The customer's requirements and the DFMEA's team discussions should drive the function's description. It is recommended that any interfaces or components with multiple functions and different failure modes are listed separately.

A design review will enable the identification of:

- Main components;
- Component function(s) (and what is not required to do); and
- Interfaces between components.

Visual aids, such as Computer Aided Design (CAD) models, drawing schematics, hand sketches and rapid prototyping, should be used to create a common understanding.

Item	Function
Insulated Wall Panel	Prevent Water Ingress

Figure 10. DFMEA step 1 outcome example – populate the item and function

Functions should use descriptive verbs and nouns and have measurable values.

Step 2: Identify expected requirements of the item function

Confirm the requirements of the function and populate the requirements column. Figure 11 illustrates the process.

Requirements should be quantified with design specifications. This will enable the failure modes to be identified. Requirements that are not defined on any drawing or specification should not be listed.

Item	Function	Requirement
Insulated Wall Panel	Prevent Water Ingress	Achieve water tightness to a pressure of 600 Pa for normal conditions, in accordance with product standard BS EN 14509

Figure 11. DFMEA step 2 outcome example - identify expected requirements

The physical interfaces or components under evaluation should be considered as requirements.

Step 3: Brainstorm potential failure modes

Brainstorm how a component, sub-system, or system could fail to deliver the function in order to identify potential failure modes. This should use information from the teams experience and include:

- Similar DFMEAs;
- Customer complaints;
- Warranty reports; and
- Manufacturing and quality reports identifying rework, damage and scrap issues.

Failure mode categories include:

- No function;
- Over function;
- Partial or degrading function;
- Intermittent function;
- Missing function; and
- Unintended function.

Multiple failure modes can exist for each requirement.

Potential failure modes should be concise statements as shown in Figure 12.

Item	Function	Requirement	Potential Failure Mode
Insulated Wall Panel	Prevent Water Ingress	Achieve water tightness to a pressure of 600 Pa for normal conditions, In accordance with product standard BS EN 14509	Panel water tightness is less than 600Pa

Figure 12. DFMEA step 3 outcome example - brainstorm potential failure modes

Step 4: Brainstorm potential failure mode effects

Against each failure mode, brainstorm and record the effects of that mode occurring. Effects should be described from a customer perspective considering the function or who and what would

be impacted: the component, the sub-assembly, assembly, or the building. Figure 13 illustrates some potential failure mode effects for the example being considered.

Item	Function	Requirement	Potential Failure Mode	Potential Failure Mode Effect
Insulated Wall Panel	Prevent Water Ingress	Achieve water tightness to a pressure of 600 Pa for normal conditions, In accordance with product standard BS EN 14509	Panel does not meet water tightness requirement	Panel allows water ingress between layers (loss of primary function)
				Panel allows water ingress at fastening point (loss of primary function)
				Panel allows water ingress at panel-to-panel interface (loss of primary function)

Figure 13. DFMEA step 4 outcome example - brainstorm potential failure mode effects

Step 5: Apply severity number (SEV) and characteristic

Severity Number

Assign a severity number to the failure mode, based on the severity of the consequences of that failure, using Table 3. Impacts on the customer and other sub-systems should be considered.

Effect	Criteria: Severity of effect on product (customer effect)	Rank
Failure to meet safety and/or regulatory requirements	Potential failure mode affects safe building operation/function and/or involves non-compliance with government regulation without warning	10
	Potential failure mode affects safe building operation/function and/or involves non-compliance with government regulation with warning	9
Loss or degradation of primary function	Loss of primary function (building inoperable or function not delivered, does not affect safety)	8
	Degradation of primary function (building operable, but at a reduced level of performance. Customer very dissatisfied)	7
Loss or degradation of secondary function	Building or product functions, but comfort/convenience reduced. Customer dissatisfied	6
	Building or product functions, but comfort/convenience at a reduced level of performance. Customer somewhat dissatisfied	5
Annoyance	Fit and finish of product does not conform. Defect noticed by most customers (greater than 75%)	4
	Fit and finish of product does not conform. Defect noticed by 50% customers	3
	Fit and finish of product does not conform. Defect noticed by discriminating customers (less than 25%)	2
No effect	No discernible effect	1

Table 3. DFMEA severity evaluation criteria

Key Characteristics

Now that the severity has been scored in the DFMEA, the team can further define Key Characteristics (KCs) as per Table 4.

In the Classification column, Critical Characteristics should be identified with the initial CC and Significant Characteristics should be identified with the initials SC.

Critical	Non-conformance would result in loss of primary function of the product resulting in catastrophic or hazardous failures without any warning. These are failures that would potentially lead to loss of lives and/or irreparable damage. Products with any critical features are automatically classified as critical products. On the DFMEA, critical features are those with potential failure modes having severity effects scored 9 or 10 on the severity scale.
Significant	Non-conformance would result in loss of primary function of the product resulting in major failures without any warning. These are failures that cause significant disruption and costs to the client. Products with any significant features are automatically classified as significant products. On the DFMEA, significant features are those with potential failure modes having severity effects scored 5 to 8 on the severity scale.
Unclassified	Non-conformance would result in loss of a functionality that causes only minor disruption to the end user. These are failures that can be repaired with relative ease and cause only minor disruptions. Products with all unclassified features are unclassified products. On the DFMEA, unclassified features are those with potential failure modes having severity effects scored less than 5 on the severity scale.

Table 4. Key Characteristics definition

Item	Function	Requirement	Potential Failure Mode	Potential Failure Mode Effect	SEV	Classification
Insulated Wall Panel	Prevent Water Ingress	Achieve water tightness to a pressure of 600 Pa for normal conditions, in accordance with product standard BS EN 14509	Panel does not meet water tightness requirement	Panel allows water ingress between layers (loss of primary function)	7	SC
				Panel allows water ingress at fastening point (loss of primary function)	7	SC
				Panel allows water ingress at panel-to-panel interface (loss of primary function)	7	SC

Figure 14. DFMEA step 5 outcome example - apply SEV number, characteristics

Step 6: Define potential failure mode cause(s)

Identify and populate the likely cause(s) for each failure mode in question, as shown in Figure 15. The failure mode cause is an underlying cause (or causes) leading to failure.

It might be helpful to ask the question: How could it happen? What initiated the mechanism leading to failure?

Item	Function	Requirement	Potential Failure Mode	Potential Failure Mode Effect	SEV	Classification	Potential Failure Mode Cause
Insulated Wall Panel	Prevent Water Ingress	Achieve water tightness to a pressure of 600 Pa for normal conditions, In accordance with product standard BS EN 14509	Panel does not meet water tightness requirement	Panel allows water ingress between layers (loss of primary function)	7	SC	Adhesive not correctly specified
				Panel allows water ingress at fastening point (loss of primary function)	7	SC	Fastener pilot specified oversized
				Panel allows water ingress at panel-to-panel interface (loss of primary function)	7	SC	Incorrect fit specified

Figure 15. DFMEA step 6 outcome example - define potential failure mode cause(s)

Step 7: Apply occurrence number (OCC)

Assign an occurrence number to the failure mode cause using guidelines in Table 5.

The occurrence evaluates the frequency of the failure mode being caused by the potential cause identified. It is a relative ranking, which can be based on real data (if available) or the team's judgement, as illustrated in Figure 16

Likelihood	Occurrence Criteria	Rank	Incidents Per Product
Very High	New technology/new design with no history	10	≥ 100 per 1,000 ≥ 1 in 10
High	Failure is inevitable with new design, new application, or change in duty cycle/ operating conditions	9	50 per 1,000 1 in 20
	Failure is likely with new design, new application, or change in duty cycle/ operating conditions	8	20 per 1,000 1 in 50
	Failure is uncertain with new design, new application or change in duty cycle/ operating conditions	7	10 per 1,000 1 in 100
Moderate	Frequent failures associated with similar designs or in design simulation and testing	6	2 per 1,000 1 in 500
	Occasional failures associated with similar designs or in design simulation and testing	5	0.5 per 1,000 1 in 2,000
	Isolated failures associated with similar designs or in design simulation and testing	4	0.1 per 1,000 1 in 10,000
Low	Only isolated failures associated with almost identical design or in design simulation and testing	3	0.01 per 1,000 1 in 100,000
	No observed failures associated with almost identical design or in design simulation and testing	2	≤0.001 per 1,000 1 in 1,000,000
Very Low	Failure is eliminated through preventive control	1	Failure is eliminated through preventive control.

Table 5. DFMEA occurrence evaluation criteria.

Item	Function	Requirement	Potential Failure Mode	Potential Failure Mode Effect	SEV	Classification	Potential Failure Mode Cause	OCC
Insulated Wall Panel	Prevent Water Ingress	Achieve water tightness to a pressure of 600 Pa for normal conditions, In accordance with product standard BS EN 14509	Panel does not meet water tightness requirement	Panel allows water ingress between layers (loss of primary function)	7	SC	Adhesive not correctly specified	3
				Panel allows water ingress at fastening point (loss of primary function)	7	SC	Fastener pilot specified oversize	2
				Panel allows water ingress at panel-to-panel interface (loss of primary function)	7	SC	Incorrect fit specified	2

Figure 16. DFMEA step 7 outcome example - apply an OCC number

Step 8: Identify prevention and detection controls

Populate the current prevention and detection controls for the design process and methods, noting that prevention is a preferred option to detection, as it stops error from occurring. Figure 17 provides an example.

Design prevention controls include but are not limited to:

- Mistake-proofing;
- Engineering design standards;
- Drawing tolerances;

- Material standards;
- Computer Simulation, e.g., Finite Element Analysis (FEA); and
- Prototype and validation testing.

Detection controls detect the failure mode after the failure has occurred but before the product is released from the design phase. These include:

- Design reviews;
- Prototype testing; and
- Validation testing.

Item	Function	Requirement	Potential Failure Mode	Potential Failure Mode Effect	SEV	Classification	Potential Failure Mode Cause	OCC	Prevention of potential Failure Mode Cause	Detection of potential Failure Mode Cause
Insulated Wall Panel	Prevent Water Ingress	Achieve water tightness to a pressure of 600 Pa for normal conditions, In accordance with product standard BS EN 14509	Panel does not meet water tightness requirement	Panel allows water ingress between layers (loss of primary function)	7	SC	Adhesive not correctly specified	3	Design Standard VS-DS-WS 014v.3	Testing of prototype to test standard VS-TP-WS-010v2
				Panel allows water ingress at fastening point (loss of primary function)	7	SC	Fastener pilot specified oversize	2	Design Standard VS-DS-WS 014v.3	Testing of prototype to test standard VS-TP-WS-010v2
				Panel allows water ingress at panel-to-panel interface (loss of primary function)	7	SC	Incorrect fit specified	2	Design Standard VS-DS-WS 014v.3	Testing of prototype to test standard VS-TP-WS-010v2

Figure 17. DFMEA step 8 outcome example - identify prevention and detection controls

Step 9: Apply detection (DET) number

Assign a detection number using the Table 6. The detection number represents the likelihood of the

failure mode being prevented or detected. An illustrative example is shown in Figure 18.

Opportunity for Detection	Criteria: Likelihood of Detection by Design Control	Rank	Likelihood of Detection
No detection opportunity	No current design control; cannot be detected or is not analysed	10	Almost impossible
Not likely to detect at any stage	Design analysis/detection controls have a weak detection capability; virtual analysis (e.g., CAE, FEA) is not correlated to expected actual operating conditions	9	Very remote
Post design freeze and prior to launch	Product verification/validation after design freeze and prior to launch with pass/fail testing (sub-system or system testing with acceptance criteria, such as ride and handling, shipping evaluation, etc.)	8	Remote
	Product verification/validation after design freeze and prior to launch with test to failure testing (sub-system or system testing until failure occurs, testing of system interactions, etc.)	7	Very Low
	Product verification/validation after design freeze and prior to launch with degradation testing (sub-system or system testing after durability test, e.g., function check)	6	Low
Prior to design freeze	Product validation (reliability testing, development or validation tests) prior to design freeze using pass/fail testing (e.g., acceptance criteria for performance, function checks, etc.)	5	Moderate
	No observed failures associated with almost identical design or in design simulation and testing	4	Moderately High
	Product validation (reliability testing, development or validation tests) prior to design freeze using degradation testing (e.g., data trends, before/after values)	3	High
Virtual analysis - correlated	Design analysis / detection controls have a strong detection capability; virtual analysis (e.g., CAE, FEA, etc.) is highly correlated to expected actual operating conditions prior to design freeze	2	Very High
Detection not applicable; failure prevention	Failure cause or failure mode cannot occur because it is fully prevented through design solutions (e.g., proven design standard, best practice or common material, etc.)	1	Almost certain

Table 6: DFMEA detection evaluation criteria

Item	Function	Requirement	Potential Failure Mode	Potential Failure Mode Effect	SEV	Classification	Potential Failure Mode Cause	OCC	Prevention of potential Failure Mode Cause	Detection of potential Failure Mode Cause	DET
Insulated Wall Panel	Prevent Water Ingress	Achieve water tightness to a pressure of 600 Pa for normal conditions, In accordance with product standard BS EN 14509	Panel does not meet water tightness requirement	Panel allows water ingress between layers (loss of primary function)	7	SC	Adhesive not correctly specified	3	Design Standard VS-DS-WS 014v.3	Testing of prototype to test standard VS-TP-WS-010v2	4
				Panel allows water ingress at fastening point (loss of primary function)	7	SC	Fastener pilot specified oversize	2	Design Standard VS-DS-WS 014v.3	Testing of prototype to test standard VS-TP-WS-010v2	4
				Panel allows water ingress at panel-to-panel interface (loss of primary function)	7	SC	Incorrect fit specified	2	Design Standard VS-DS-WS 014v.3	Testing of prototype to test standard VS-TP-WS-010v2	4

Figure 18. DFMEA step 9 outcome example - apply a DET number

Step 10: Calculate Risk Priority Number (RPN)

Calculate the RPN for each identified failure mode and potential cause of failure using the following calculation:

Severity (SEV) x Occurrence (OCC) x Detection (DET), as per Figure 19.

- For the SEV score, use the highest number for the failure mode i.e., the worst-case scenario;

- For the OCC score, use each potential failure mode - giving an RPN score for each potential failure cause identified for a particular failure mode; and
- For the DET score, use the lowest score identified for the failure mode and its associated potential cause, i.e., the best-case scenario.

The RPN gives a risk number, from one to one thousand, with one being the lowest potential risk and one thousand the highest. Figure 20 illustrates the process.

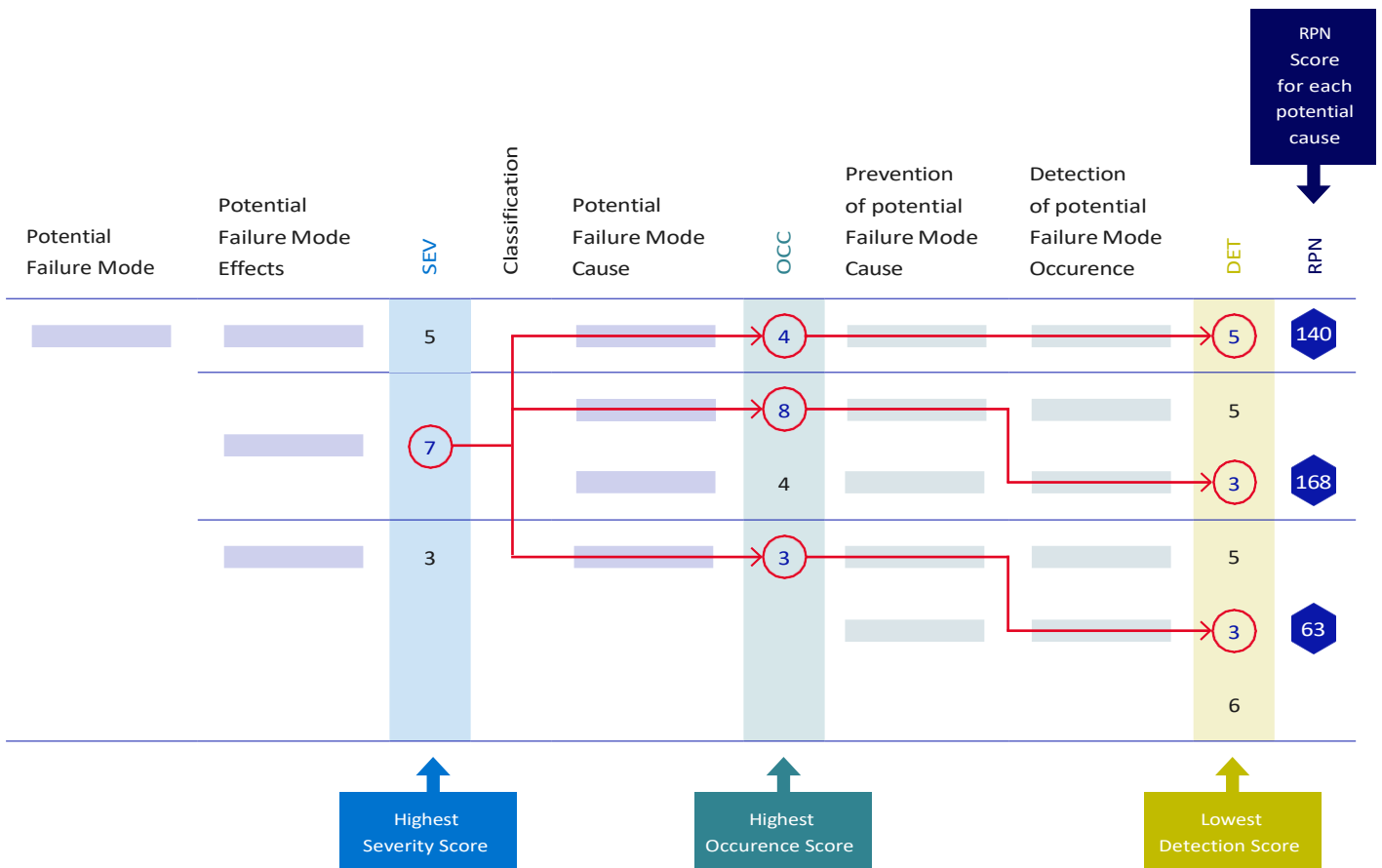

Figure 19. DFMEA RPN calculation guide

Item	Function	Requirement	Potential Failure Mode	Potential Failure Mode Effect	SEV	Classification	Potential Failure Mode Cause	OCC	Prevention of potential Failure Mode Cause	Detection of potential Failure Mode Cause	DET	RPN
Insulated Wall Panel	Prevent Water Ingress	Achieve water tightness to a pressure of 600 Pa for normal conditions, In accordance with product standard BS EN 14509	Panel does not meet water tightness requirement	Panel allows water ingress between layers (loss of primary function)	7	SC	Adhesive not correctly specified	3	Design Standard VS-DS-WS 014v.3	Testing of prototype to test standard VS-TP-WS-010v2	4	84
				Panel allows water ingress at fastening point (loss of primary function)	7	SC	Fastener pilot specified oversized	2	Design Standard VS-DS-WS 014v.3	Testing of prototype to test standard VS-TP-WS-010v2	4	56
				Panel allows water ingress at panel-to-panel interface (loss of primary function)	7	SC	Incorrect fit specified	2	Design Standard VS-DS-WS 014v.3	Testing of prototype to test standard VS-TP-WS-010v2	4	56

Figure 20. DFMEA step 10 outcome example – RPN calculation

Step 11: Develop an improvement action plan & execute

Use the calculated RPN to prioritise and define an action plan to reduce RPNs to an acceptable level. Actions should be taken for any failure mode effect with a severity greater than 7.

- Action owners and completion deadlines should be specified;
- Reduction in RPNs is usually achieved by lowering occurrence or detection, independently or together. The reduction needs to be verified;
- Severity reductions cannot be achieved if the failure mode and its effect still exist. A design change eliminating the function and therefore the failure mode and effect can do so;

- Occurrence reductions are achieved through prevention or control; and
- Detection reductions are achieved by improving prevention or detection controls.

During the design of the product, initial versions of the DFMEA may have very high RPNs. It is important to use the DFMEA tool to improve the design process. It should be updated and RPN recalculated in order to measure the effect of the improvement action. Figure 21 shows an example of a DFMEA improvement action list.

DFMEA is an ongoing process, with final review taking place at the end of Phase 2 of the CPQP. After this point, any further changes to the DFMEA would need to go through a controlled design change process. As long as the product is being manufactured, DFMEA should not be retired as the need for design change may arise.

Recommendations				Action Results					
Recommended Improvement/ Corrective Actions	Action Owner	Target Completion Date	Responsible Business/ Department	Actual improvement/ Corrective Actions Implemented	Actual Completion Date	SEV	OCC	DET	RPN
Prototype testing at 50Pa using holes sizes specified in the Design Standard	-	March 2020	Development	Prototype testing at 50Pa using hole sizes specified implemented	March 2020	6	2	4	48
Prototype testing at 50Pa using adhesive specified	-	March 2020	Development	Prototype testing at 50Pa using adhesive specified implemented	March 2020	6	2	4	48
Implement simulation analysis (FEA) and validate through prototype testing	-	March 2020	Design	Simulation carried out and design changed in accordance with results. Validated through prototype testing	April 2020	10	2	2	40

Figure 21. DFMEA step 11 outcome example – sample improvement actions



References and Appendices

References

- [1] Construction Product Quality Planning Guide. (2020). UK: Construction Innovation Hub.
- [2] Automotive Industry Action Group. (2008). Advanced product quality planning (APQP) and control plan reference manual (2nd ed.). Southfield, MI: AIAG.
- [3] British Standards Institution. (2018). Aerospace Series – Requirements for advanced product quality planning and production part approval process. BS EN 9145. UK: British Standards Institution.
- [4] Tanner, S. & Bailey, M. (2014). The business improvement handbook (4th ed.). London, UK: BSI Group.

Appendices

Appendix A – Tool Template

Templates to be used within the context of this guideline are available, please contact: cpqp@constructioninnovationhub.org.uk

Appendix B – List of Abbreviations

The following is a list of initialisations and acronyms used in this guideline.

A	APQP	Advanced Product Quality Planning
B	BOM	Bill of Materials
C	CAD	Computer Aided Design
	CC	Critical Characteristic
	CI	Critical Item
	CPQP	Construction Product Quality Planning
D	DET	Detection (score)
	DFMEA	Design Failure Mode and Effects Analysis
F	FEA	Finite Element Analysis
	FMEA	Failure Mode and Effects Analysis
K	KC	Key Characteristic
O	OCC	Occurrence (score)
R	RPN	Risk Priority Number
S	SC	Significant Characteristic
	SEV	Severity (score)

Appendix C – Glossary of Terms

The following is a list of commonly utilised quality, manufacturing and construction specific terms and their definitions within this context used within this guideline.

- A** Advanced Product Quality Planning (APQP)
A quality framework used for developing new products. It was developed by the automotive industry but can be applied to any industry and is similar in many respects to the concept of design for six sigma; see AIAG Reference Manual [2].
- C** Construction Product Quality Planning (CPQP)
An adaptation of Advanced Product Quality Planning (APQP) that is aimed at those enterprises that will feed construction with new componentry for offsite builds.
- Critical Characteristic (CC)
An attribute or feature whose non-conformance would result in loss of primary function of the product resulting in catastrophic or hazardous failures without any warning. These are failures that would potentially lead to loss of life and/or irreparable damage.
- Critical Item (CI)
BS EN 9145 [3]: 'Those items (e.g., functions, parts, software, characteristics, processes) having significant effect on the product realization and use of the product; including safety, performance, form, fit, function, producibility, service life, etc.; that require specific actions to ensure they are adequately managed.'
- D** Design Failure Mode and Effects Analysis (DFMEA)
An application of Failure Mode and Effects Analysis (FMEA) for product design.
- F** Failure Mode and Effects Analysis (FMEA)
'A tool for facilitating the process of predicting failures, planning preventative measures, estimating the cost of the failure, and planning redundant systems or system responses to failures [4].' 'The FMEA assists in the identification of Critical Items (CIs) as well as key design and process characteristics, helps prioritize action plans for mitigating risk and serves as a repository for lessons learned [3].'
- S** Significant Characteristic (SC)
An attribute or feature whose non-conformance would result in loss of primary function of the product resulting in major failures without any warning. These are failures that cause significant disruption and costs to the client.

Disclaimer

This disclaimer governs the use of this publication and by using this publication, you accept the terms of this disclaimer in full. The information contained within this publication does not constitute the provision of technical or legal advice by the Construction Innovation Hub or any of its members and any use made of the information within the publication is at the user's own discretion. This publication is provided 'as is' and neither the Construction Innovation Hub nor any of its members accept liability for any errors within this publication or for any losses arising out of or in connection with the use or misuse of this publication. Nothing in this disclaimer will exclude any liability which cannot be executed or limited by law.

The Construction Innovation Hub is funded by UK Research and Innovation through the Industrial Strategy Challenge Fund



The Construction Innovation Hub is a consortium between:

